

Loan Recipient	L17-	Project Description	Initiation of Operation	Final Completion	Final Costs	Loan Amount
Geneva	0986	<p>Sludge Handling The proposed project consists of upgrading the City's sludge handling facilities, floodproofing and providing upgraded employee facilities specifically including the following improvements: Two new anaerobic digesters with covers and equipment; Control building to house sludge digester pumping equipment/piping, a heat exchanger system and digester gas/safety equipment; Conversion of the digester settling tanks to waste activated sludge thickening tanks with covers and the addition of a polymer feed system; Upgrade the sludge scraper mechanisms on the final clarifiers and replacement of one of the skimmer arms; Remodeling the service building to include an employee washroom/lunchroom and conversion of the abandoned anaerobic digester into workshop, laboratory and office facilities; Relocation of a centrifugal blower to the blower building; Floodproofing the service building and service building transformer, the drive units for the digester settling tanks, sludge pumping station and influent pumping station transformer, and; Abandonment of the aerobic and anaerobic digester, and all necessary piping, wiring and site work to make the project complete and operational.</p>	8/17/2000	10/18/2000	\$5,400,000.00	
Geneva	1854	<p>STP Expansion/Nitrification The project consists of the following improvements: Mechanical bar screen, aerated grit tank and flow splitter box; Expand influent wet well and add two raw sewage pumps; Two primary clarifiers, one final clarifier and three aeration tanks; Two centrifuges, return/waste activated sludge pump stations and sludge storage pad all housed in building structure; Eliminate existing final clarifier covers and upgrade existing primary clarifiers and aeration tanks; Convert existing digester for sidestream treatment; Upgrade three existing blowers and add two blowers with building; Add influent/effluent flow measurement and sampling devices; Relocate wet weather flow pipe and provide wet weather flow diversion channels; New ultraviolet disinfection system and wet weather flow chlorination/dechlorination system, and; All necessary demolition, computer integration systems, piping, electrical and site work to make the project complete and operational.</p>	11/15/2004	11/15/2004	\$5,500,000.00	

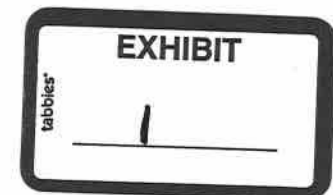

Loan Recipient	L17-	Project Description	Initiation of Operation	Final Completion	Final Costs	Loan Amount
Batavia	1385	<p>STP Upgrade & Expansion The proposed project consists of the upgrade and expansion of the Batavia Wastewater Treatment Facility to a Design Average Flow (DAF) of 4.20 MGD and a Design Maximum Flow (DMF) of 9.81 MGD. Specifically, the proposed project includes the construction of an influent flow measurement structure (Parshall flume), installation of a new mechanical bar screen, construction of a new primary settling tank, replacement of primary clarifier equipment in the existing tanks, installation of new aeration diffusers in the existing aeration tanks, addition of one pump to the intermediate pump station, construction of two new aeration (nitrification) basins including blowers and diffusers, construction of a mixed liquor suspended solids diversion/return activated sludge metering structure, construction of a new final settling tank, modification of the existing clarifier mechanisms, construction of new ultraviolet disinfection facilities, installation of a new effluent magnetic flow meter, rehabilitation of the existing anaerobic digesters along with all necessary ancillary appurtenances to make the Batavia Wastewater Treatment Facility complete and operational.</p>	2/1/2001	12/31/2001	\$10,791,000.00	
St. Charles	2288	<p>STP Upgrade The project consists of the following improvements: Modifications of the headworks diversion structure; Rehabilitate the ferric chloride and grit buildings; Replace the scum troughs on the primary clarifiers; Construct an additional 2.8 million gallons of aeration basin capacity; Construct a new blower building with blowers and associated equipment; Rehabilitation of the existing aeration basins; Install baffles in the final clarifiers, and tipping buckets and new weirs in the wet weather flow clarifiers; Replace pumps and adjustable frequency drives on the return activated and waste activated sludge pump stations; Construct new ultra-violet disinfection facilities, and; All necessary appurtenances, site work, piping, electrical and restoration to make the project complete and operational.</p>	7/9/2005	7/9/2005	\$9,871,043.00	

Loan Recipient	L17-	Project Description	Initiation of Operation	Final Completion	Final Costs	Loan Amount
Kishwaukee WRD	2986	<p>STP Upgrade/Filters, Sludge Handling Funds will be utilized at the Wastewater Treatment Plant (WWTP) to upgrade and rehabilitate the biosolids handling process. Digesters will be outfitted with new covers, heating systems, and mixing systems. A digester control building will be constructed and piping will be rerouted to provide an even split between digesters. A new sludge handling building with truck bays and a new sludge storage barn will be constructed. New equipment to capture and utilize methane gas will be installed. The tertiary filtration system will be rehabilitated and the SCADA system will be upgraded. The project also includes 495 feet of 8-16 inch sewer and 7 manholes to transfer sludge to and from the handling building.</p> <p>The existing Country Club lift station will be demolished. A new Country Club lift station with two pumps each rated at 2,000 gallons per minute will be constructed. The new lift station will be connected to an existing sewer by 121 feet of 12-inch forcemain and 469 feet of sanitary sewer ranging in diameter from 12 to 30 inches. Project includes all necessary appurtenances.</p>	10/18/2011	10/31/2012	\$20,071,936.00	
Newark Sanitary Di	2899	<p>STP Expansion The proposed project consists of improving the Village's existing wastewater treatment plant in order to replace outdated/failing equipment, provide for ammonia removal, provide for phosphorous removal, and meet future expansion needs. This loan covers Phase I of the proposed improvements, which specifically entails modifying and supplementing the existing aerated lagoon system.</p>	6/7/2018	7/7/2018	\$2,957,269.00	
Fox River WRD	2518	<p>South STP Ammonia Reduction The purpose of the project is to meet more stringent ammonia-nitrogen effluent limits that will go into effect for FRWRD's South Plant during December 2006. Two 400,000-gallon capacity flow equalization tanks will be constructed. The tanks will be utilized to control the amount of ammonia containing filtrate that is returned to the beginning of the secondary treatment process; therefore, eliminating high level peaks. The tanks will each have a submersible pump and mixing equipment. A small building to house filtrate flow meter and electrical equipment will be constructed between the new tanks.</p>	9/5/2006	10/12/2007	\$1,979,131.00	

Loan Recipient	L17-	Project Description	Initiation of Operation	Final Completion	Final Costs	Loan Amount
Mount Carmel	5320	<p>Sewer Plant and Outfall Upgrades This loan will fund new fine bubble aeration equipment that will allow the City to achieve compliance with the ammonia limits in their National Pollutant Discharge Elimination System (NPDES) permit. The new extended aeration basins will have 490 – nine-inch diffuser discs and the aerobic digester will have 357 discs, for a total of 1,337 diffuser discs. A backup electric generator is also included in the scope of work. This work is identified as Contract A.</p> <p>The current outfall pipe will be relocated. Work will consist of the installation of 3,650 feet of 36-inch high-density polyethylene (HDPE) sewer line, 8 sanitary sewer manholes, and a new river outfall structure. This work is identified as Contract B.</p>	Not Final	Not Final	Not Final	\$3,475,122.00



ILLINOIS ENVIRONMENTAL PROTECTION AGENCY

1021 NORTH GRAND AVENUE EAST, P.O. BOX 19276, SPRINGFIELD, ILLINOIS 62794-9276 • (217) 782-3397

PAT QUINN, GOVERNOR

JOHN J. KIM, INTERIM DIRECTOR

Memorandum

DATE: October 23, 2012
TO: Mark Liska
FROM: Brian Koch *BK*
SUBJECT: Standards Unit Review of Biomonitoring Test Results
RE: Emerald Performance Materials - IL0001392 (Marshall County)

Standards Unit has reviewed toxicity test results conducted under biomonitoring requirements to be fulfilled prior to the expiration of the permit for the following facility:

Emerald Performance Materials - IL0001392

A summary of the toxicity data is found on the attached review sheet. High to severe acute toxicity to fathead minnow and *Ceriodaphnia* was observed in each bioassay. Fathead minnow toxicity was attributed to the extremely high ammonia concentrations within effluent. However, the facility has been operating under an IPCB adjusted standard (AS 2002-005) which authorizes effluent concentrations up to 155 mg/L ammonia. The adjusted standard expired in November, 2011, but the facility is now petitioning IPCB (AS 2012-002) for continuation of the previous adjusted standard. *Ceriodaphnia* toxicity may have also been attributed to ammonia, but the extremely high conductivity measurements (maximum of 19,350 μ mhos, equivalent to 11,606 mg/L TDS) suggest that dissolved solids such as sulfate and chloride are also present at acutely toxic concentrations. The facility's current NPDES permit does not require effluent monitoring for these parameters, so the magnitude of each parameter is unknown.

Recommendations: The current NPDES permit will not be renewed until IPCB rules on the adjusted standard petition presently before them. Subsequently, the biomonitoring recommendation for the upcoming permit will not be determined until IPCB action. However, it should be noted that regardless of the IPCB decision, the upcoming permit should be modified to limit or monitor sulfate and chloride (or justify mixing is available for these parameters) and account for whole effluent toxicity due to these parameters.

Attachment

Distribution List

Bob Mosher
Darin LeCrone ✓
Jim KammueLLer
Bill Ettinger
Records Unit

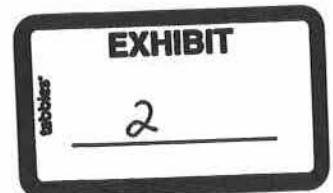

4302 N. Main St., Rockford, IL 61103 (815)987-7760
595 S. State, Elgin, IL 60123 (847)608-3131
2125 S. First St., Champaign, IL 61820 (217)278-5800
2009 Mall St., Collinsville, IL 62234 (618)346-5120

9511 Harrison St., Des Plaines, IL 60016 (847)294-4000
5407 N. University St., Arbor 113, Peoria, IL 61614 (309)693-5462
2309 W. Main St., Suite 116, Marion, IL 62959 (618)993-7200
100 W. Randolph, Suite 11-300, Chicago, IL 60601 (312)814-6026

PLEASE PRINT ON RECYCLED PAPER

01956

BIOMONITORING TEST RESULTS SUMMARY

Reviewer's Name: Brian Koch	Date Summarized: 10/23/12	Results Received: 10/18/12
Facility Name: Emerald Performance Materials	NPDES No.: IL0001392	Expiration Date: 04/30/12
Receiving Water: Illinois River	Segment Code: D-09	

Upstream 7Q10: 3526 CFS	Discharge Average Flow (2011): 1.42 CFS
Dilution Ratio: 2483:1 Instream Waste Concentration: 0.04% Waste concentration in 25% of dilution water: 0.16%	

Facility Type: Industrial
Treatment Level:
Process Information/Notes: Manufacturer of rubber accelerators and antioxidants for the rubber, lubricant and plastics industries. Extremely high ammonia due to the breakdown of amines used in the manufacturing process.

TOXICITY DATA

Bioassay Date: 06/15/11	Laboratory: EAS	Test Sponsor: Emerald Performance Materials
Dilution Water Source: Illinois River	Receiving Water Toxicity: Not toxic	
Effluent Ammonia (total-N): 88.8 mg/L	Effluent Chlorine (TRC): <0.04 mg/L	
Acute Bioassays: Definitive <i>Ceriodaphnia</i> : LC50 = 11.3% effluent		
Definitive Fathead Minnow: LC50 = 8.5% effluent		
Test Notes: Conductivity was 13330 µmhos.		
Bioassay Date: 07/27/11	Laboratory: EAS	Test Sponsor: Emerald Performance Materials
Dilution Water Source: Illinois River	Receiving Water Toxicity: Not toxic	
Effluent Ammonia (total-N): 99.9 mg/L	Effluent Chlorine (TRC): 0.72 mg/L	
Acute Bioassays: Definitive <i>Ceriodaphnia</i> : LC50 = 12.5% effluent		
Definitive Fathead Minnow: LC50 = 8.7% effluent		
Test Notes: Conductivity was 19350 µmhos.		
Bioassay Date: 10/12/11	Laboratory: EAS	Test Sponsor: Emerald Performance Materials
Dilution Water Source: Illinois River	Receiving Water Toxicity: Not toxic	
Effluent Ammonia (total-N): 59.9 mg/L	Effluent Chlorine (TRC): <0.04 mg/L	
Acute Bioassays: Definitive <i>Ceriodaphnia</i> : LC50 = 31.9% effluent		
Definitive Fathead Minnow: LC50 = 22.8% effluent		
Test Notes: Conductivity was 14850 µmhos.		
Bioassay Date: 01/25/12	Laboratory: EAS	Test Sponsor: Emerald Performance Materials
Dilution Water Source: Illinois River	Receiving Water Toxicity: Not toxic	
Effluent Ammonia (total-N): 72.2 mg/L	Effluent Chlorine (TRC): <0.04 mg/L	
Acute Bioassays: Definitive <i>Ceriodaphnia</i> : LC50 = <6.25% effluent		
Definitive Fathead Minnow: LC50 = 9.42% effluent		
Test Notes: Conductivity was 12410 µmhos.		

Other Bioassays: See PLO file for earlier WET tests.

Test Date	Laboratory	Dilution Water Source	Acute Bioassays	Chronic Bioassays/Ammonia

Date/Result of Most Recent IEPA Biosurvey: None.

Comments: High to severe acute toxicity to fathead minnow and *Ceriodaphnia* was observed in each bioassay. Fathead minnow toxicity was attributed to the extremely high ammonia concentrations within effluent. However, the facility has been operating under an IPCB adjusted standard (AS 2002-005) which authorizes effluent concentrations up to 155 mg/L ammonia. The adjusted standard expired in November, 2011, but the facility is now petitioning IPCB (AS 2012-002) for continuation of the previous adjusted standard. *Ceriodaphnia* toxicity may have also been attributed to ammonia, but the extremely high conductivity measurements (maximum of 19,350 μ mhos, equivalent to 11,606 mg/L TDS) suggest that dissolved solids such as sulfate and chloride are also present at acutely toxic concentrations. The facility's current NPDES permit does not require effluent monitoring for these parameters, so the magnitude of each parameter is unknown.

Recommendations: The current NPDES permit will not be renewed until IPCB rules on the adjusted standard petition presently before them. Subsequently, the biomonitoring recommendation for the upcoming permit will not be determined until IPCB action. However, it should be noted that regardless of the IPCB decision, the upcoming permit should be modified to limit or monitor sulfate and chloride (or justify mixing is available for these parameters) and account for whole effluent toxicity due to these parameters.

BIOMONITORING TEST RESULTS SUMMARY

Reviewer's Name: **Brian Koch** Date Summarized: **06/16/15** Results Received: **11/22/13**
Facility Name: **Emerald Performance Materials** NPDES No.: **IL0001392** Expiration Date: **04/30/12**
Receiving Water: **Illinois River** Segment Code: **D-09**

Upstream 7Q10: **3526 CFS** Discharge Average Flow (2014): **1.25 CFS**
Dilution Ratio: **2821:1** Instream Waste Concentration: **0.035%** Waste concentration in 25% of dilution water: **0.14%**

Facility Type: **Industrial**
Treatment Level:
Process Information/Notes: **Manufacturer of rubber accelerators and antioxidants for the rubber, lubricant and plastics industries. Extremely high ammonia due to the breakdown of amines used in the manufacturing process.**

TOXICITY DATA

Bioassay Date: **06/15/11** Laboratory: **EAS** Test Sponsor: **Emerald Performance Materials**

Dilution Water Source: **Illinois River** Receiving Water Toxicity: **Not toxic**

Effluent Ammonia (total-N): **88.8 mg/L** Effluent Chlorine (TRC): **<0.04 mg/L**

Acute Bioassays: Definitive *Ceriodaphnia*: **LC50 = 11.3% effluent**
Definitive Fathead Minnow: **LC50 = 8.5% effluent**

Test Notes: **Conductivity was 13330 µmhos.**

Bioassay Date: **07/27/11** Laboratory: **EAS** Test Sponsor: **Emerald Performance Materials**

Dilution Water Source: **Illinois River** Receiving Water Toxicity: **Not toxic**

Effluent Ammonia (total-N): **99.9 mg/L** Effluent Chlorine (TRC): **0.72 mg/L**

Acute Bioassays: Definitive *Ceriodaphnia*: **LC50 = 12.5% effluent**
Definitive Fathead Minnow: **LC50 = 8.7% effluent**

Test Notes: **Conductivity was 19350 µmhos.**

Bioassay Date: **10/12/11** Laboratory: **EAS** Test Sponsor: **Emerald Performance Materials**

Dilution Water Source: **Illinois River** Receiving Water Toxicity: **Not toxic**

Effluent Ammonia (total-N): **59.9 mg/L** Effluent Chlorine (TRC): **<0.04 mg/L**

Acute Bioassays: Definitive *Ceriodaphnia*: **LC50 = 31.9% effluent**
Definitive Fathead Minnow: **LC50 = 22.8% effluent**

Test Notes: **Conductivity was 14850 µmhos.**

Bioassay Date: **01/25/12** Laboratory: **EAS** Test Sponsor: **Emerald Performance Materials**

Dilution Water Source: **Illinois River** Receiving Water Toxicity: **Not toxic**

Effluent Ammonia (total-N): **72.2 mg/L** Effluent Chlorine (TRC): **<0.04 mg/L**

Acute Bioassays: Definitive *Ceriodaphnia*: **LC50 = <6.25% effluent**
Definitive Fathead Minnow: **LC50 = 9.42% effluent**

Test Notes: **Conductivity was 12410 µmhos.**

Bioassay Date: 11/12/13 Laboratory: Microbac Test Sponsor: Emerald Performance Materials

Dilution Water Source: Illinois River

Receiving Water Toxicity: Not toxic

Effluent Ammonia (total-N): 25.0 mg/L

Effluent Chlorine (TRC): 0.06 mg/L

Acute Bioassays: Definitive *Ceriodaphnia*: LC50 = 16.5% effluent

Definitive Fathead Minnow: LC50 = 16.8% effluent

Test Notes: Conductivity was estimated at 15222 µmhos.

Other Bioassays: See PLO file for earlier WET tests.

Test Date	Laboratory	Dilution Water Source	Acute Bioassays	Chronic Bioassays/Ammonia

Date/Result of Most Recent IEPA Biosurvey: None.

Comments: High to severe acute toxicity to fathead minnow and *Ceriodaphnia* was observed in each bioassay. Fathead minnow toxicity was attributed to the extremely high ammonia concentrations within effluent. However, the facility has been operating under an IPCB adjusted standard (AS 2002-005) which authorizes effluent concentrations up to 155 mg/L ammonia. The adjusted standard expired in November, 2011, but the facility has recently been granted new IPCB relief (AS 2013-002) which allows a daily maximum of 140 mg/L total ammonia nitrogen. *Ceriodaphnia* toxicity may have also been attributed to ammonia, but the extremely high conductivity measurements (maximum of 19,350 µmhos, equivalent to 11,606 mg/L TDS) suggest that dissolved solids such as sulfate and chloride are also present at acutely toxic concentrations. The facility's current NPDES permit does not require effluent monitoring for these parameters, so the magnitude of each parameter is unknown.

Recommendations: Annual biomonitoring with fathead minnow and *Ceriodaphnia* is recommended. The facility has recently been granted new IPCB relief (AS 2013-002) which allows a daily maximum of 140 mg/L total ammonia nitrogen. Thus, acute whole effluent toxicity attributed to ammonia is permissible providing that effluent samples do not exceed 140 mg/L total ammonia nitrogen. Given the extremely high ammonia concentrations in the effluent, testing of 100% and 50% effluent treatments will nearly always be toxic to test organisms. Therefore, a revised dilution series centered around the instream waste concentration of the effluent is recommended. A CORMIX ZID analysis on this facility determined that the facility has a dilution allowance of 47.9:1, which equates to an effluent concentration of 2.1% which should be used as the effluent concentration that shall not be acutely toxic to test organisms. Based on the instream waste concentration, the dilution series to be required in the renewed permit shall consist of 12.5%, 6.25%, 3.125%, 1.565%, and 0.78% effluent. A revised special condition that contains the new dilution series and an acute LC50 limit of 2.1% effluent is attached.

SPECIAL CONDITION SPECIAL CONDITION NO.~. The Permittee shall conduct annual biomonitoring using Outfall 001 effluent.

Biomonitoring

1. Acute Toxicity - Standard definitive acute toxicity tests shall be run on at least two trophic levels of aquatic species (fish, invertebrate) representative of the aquatic community of the receiving stream. Testing must be consistent with Methods for Measuring the Acute Toxicity of Effluents and Receiving Waters to Freshwater and Marine Organisms (Fifth Ed.) EPA/821-R-02-012. Unless substitute tests are pre-approved; the following tests are required:
 - a. Fish - 96 hour static LC₅₀ Bioassay using fathead minnows (*Pimephales promelas*).
 - b. Invertebrate 48-hour static LC₅₀ Bioassay using *Ceriodaphnia*.
2. Test Requirements - The above test shall be conducted annually using 24-hour composite samples unless otherwise authorized by the IEPA. Effluent samples must be analyzed for ammonia given that this parameter may be associated with acute toxicity. The dilution series to be utilized shall consist of the following: 12.5%, 6.25%, 3.125%, 1.565%, and 0.78% effluent.
3. Reporting - Results shall be reported according to EPA/821-R-02-012, Section 12, Report Preparation, and shall be submitted to IEPA, Bureau of Water, Compliance Assurance Section within one week of receipt from the laboratory. Results from ammonia analysis, as well as any other parameter believed to contribute to effluent toxicity, must be included in the bioassay report.
4. Toxicity - Should a bioassay indicate an acute LC50 of less than 2.1% effluent and the effluent is found to contain non-toxic amounts of ammonia, the IEPA may require, upon notification, six (6) additional rounds of monthly testing on the affected organism(s) to be initiated within 30 days of the toxic bioassay. Results shall be submitted to IEPA within one (1) week of becoming available to the Permittee.
5. Toxicity Identification and Reduction Evaluation - Should any of the additional bioassays indicate an acute LC50 of less than 2.1% effluent and the effluent is found to contain non-toxic amounts of ammonia, the Permittee must contact the IEPA within one (1) day of the results becoming available to the Permittee and begin the toxicity identification evaluation process in accordance with Methods for Aquatic Toxicity Identification Evaluations, EPA/600/6-91/003. The IEPA may also require, upon notification, that the Permittee prepare a plan for toxicity reduction evaluation to be developed in accordance with Toxicity Reduction Evaluation Guidance for Municipal Wastewater Treatment Plants, EPA/833B-99/002, which shall include an evaluation to determine which chemicals have a potential for being discharged in the plant wastewater, a monitoring program to determine their presence or absence and to identify other compounds which are not being removed by treatment, and other measures as appropriate. The Permittee shall submit to the IEPA its plan for toxicity reduction evaluation within ninety (90) days following notification by the IEPA. The Permittee shall implement the plan within ninety (90) days or other such date as contained in a notification letter received from the IEPA.

The IEPA may modify this Permit during its term to incorporate additional requirements or limitations based on the results of the biomonitoring. In addition, after review of the monitoring results, the IEPA may modify this Permit to include numerical limitations for specific toxic pollutants. Modifications under this condition shall follow public notice and opportunity for hearing.

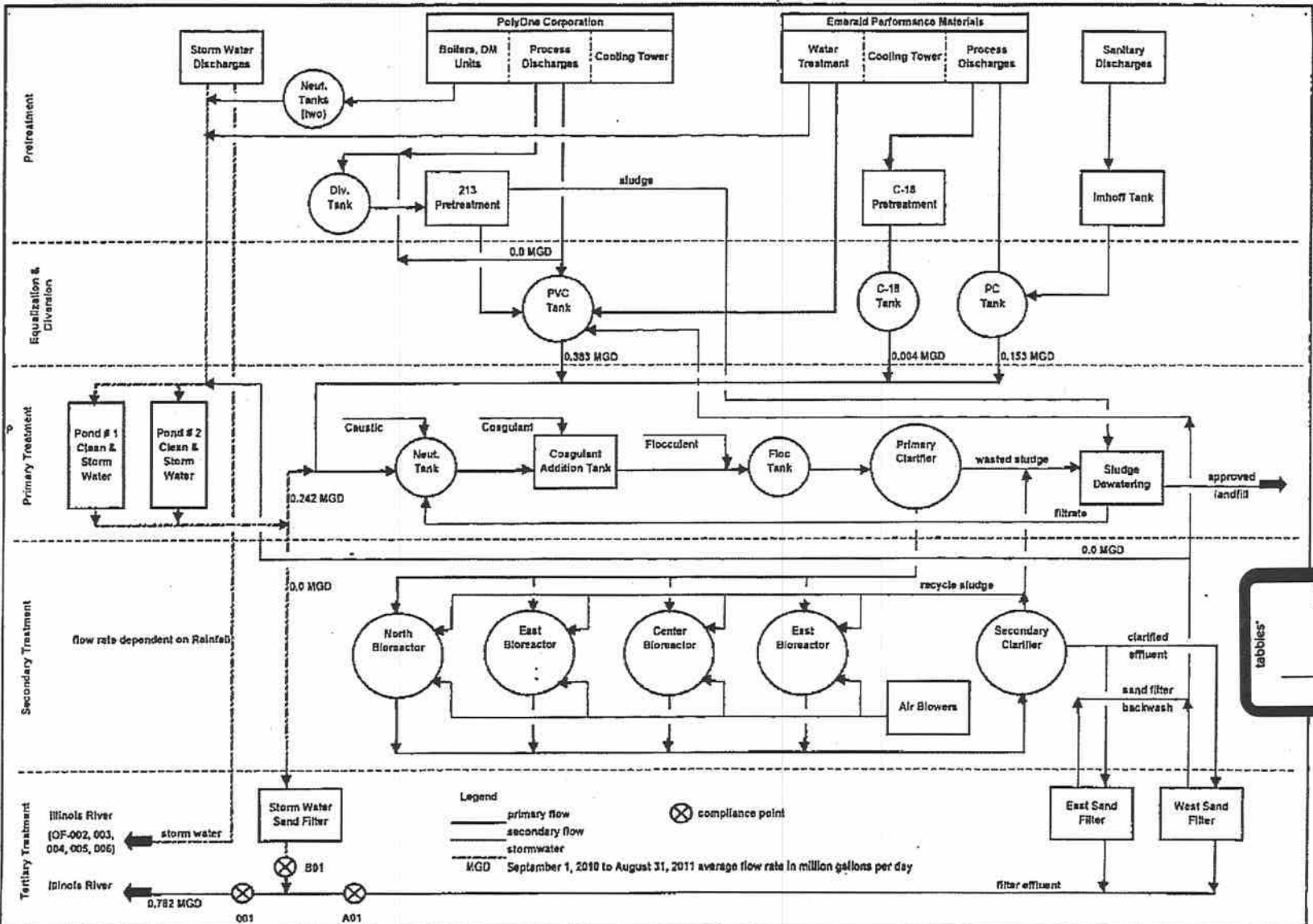

EXHIBIT
4

Drawn LAG Checked HC
Date 10/28/2011 Date 10/31/2011

SOURCES AND USERS FLOW DIAGRAM

EMERALD PERFORMANCE MATERIALS

AH-2884 REV D

1550 County Road 1450 N - Henry, Illinois

scale: none

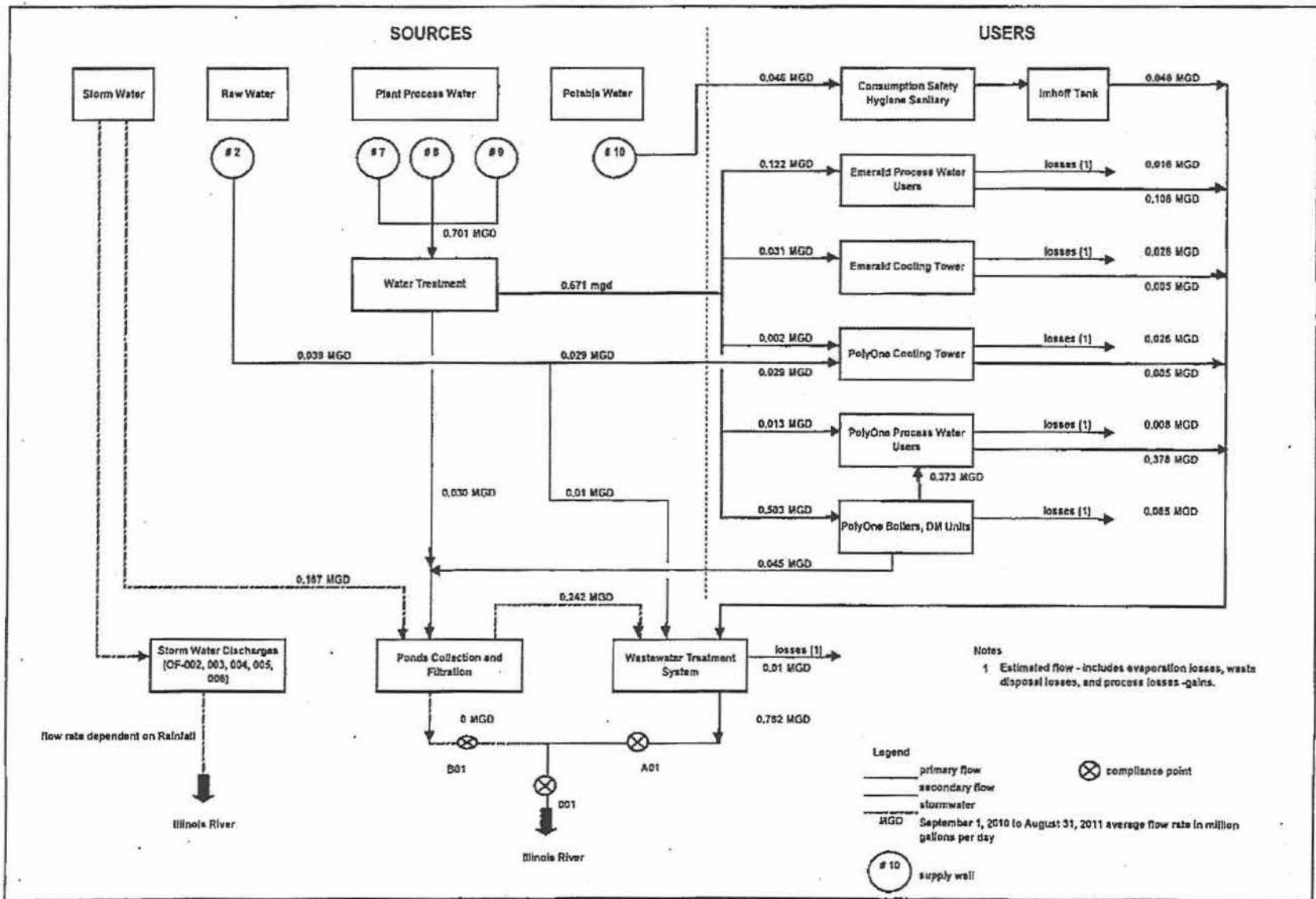

Drawn LAG Checked HC
 Date 10/28/2011 Date 10/31/2011

SOURCES AND USERS FLOW DIAGRAM

EMERALD PERFORMANCE MATERIALS

AH-2883 REV C

1550 County Road 1450 N - Henry, Illinois

scale: none

NPDES ID	Facility Name	State Water Body	Mon. Period End Date	Limit Set	Param Cd - MLC - Season ID	Parameter	Mon. Loc. Desc.	Worst % exceed.	Quantity 1	Quantity 2	Quantity Units	Concentration 1	Concentration 2	Concentration 3	Concentration Units	Effluent Vio. Exists	Slay Type Code	Change of Limit Status Code	Limit Type Code
IL0001392	EMERALD POLYMER ADDITIVES LLC	07130001-ILLINOIS RIVER	11/30/2019	001-0	00600-1-0	Nitrogen, total [as N]	Effluent Gross							63	mg/L	N		BAS	ENF
IL0001392	EMERALD POLYMER ADDITIVES LLC	07130001-ILLINOIS RIVER	10/31/2019	001-0	00600-1-0	Nitrogen, total [as N]	Effluent Gross							89	mg/L	N		BAS	ENF
IL0001392	EMERALD POLYMER ADDITIVES LLC	07130001-ILLINOIS RIVER	09/30/2019	001-0	00600-1-0	Nitrogen, total [as N]	Effluent Gross							78	mg/L	N		BAS	ENF
IL0001392	EMERALD POLYMER ADDITIVES LLC	07130001-ILLINOIS RIVER	08/31/2019	001-0	00600-1-0	Nitrogen, total [as N]	Effluent Gross							100	mg/L	N		BAS	ENF
IL0001392	EMERALD POLYMER ADDITIVES LLC	07130001-ILLINOIS RIVER	07/31/2019	001-0	00600-1-0	Nitrogen, total [as N]	Effluent Gross							88	mg/L	N		BAS	ENF
IL0001392	EMERALD POLYMER ADDITIVES LLC	07130001-ILLINOIS RIVER	06/30/2019	001-0	00600-1-0	Nitrogen, total [as N]	Effluent Gross							77	mg/L	N		BAS	ENF
IL0001392	EMERALD POLYMER ADDITIVES LLC	07130001-ILLINOIS RIVER	05/31/2019	001-0	00600-1-0	Nitrogen, total [as N]	Effluent Gross							84	mg/L	N		BAS	ENF
IL0001392	EMERALD POLYMER ADDITIVES LLC	07130001-ILLINOIS RIVER	04/30/2019	001-0	00600-1-0	Nitrogen, total [as N]	Effluent Gross							90	mg/L	N		BAS	ENF
IL0001392	EMERALD POLYMER ADDITIVES LLC	07130001-ILLINOIS RIVER	03/31/2019	001-0	00600-1-0	Nitrogen, total [as N]	Effluent Gross							96	mg/L	N		BAS	ENF
IL0001392	EMERALD POLYMER ADDITIVES LLC	07130001-ILLINOIS RIVER	02/28/2019	001-0	00600-1-0	Nitrogen, total [as N]	Effluent Gross							97	mg/L	N		BAS	ENF
IL0001392	EMERALD POLYMER ADDITIVES LLC	07130001-ILLINOIS RIVER	01/31/2019	001-0	00600-1-0	Nitrogen, total [as N]	Effluent Gross							100	mg/L	N		BAS	ENF
IL0001392	EMERALD POLYMER ADDITIVES LLC	07130001-ILLINOIS RIVER	12/31/2018	001-0	00600-1-0	Nitrogen, total [as N]	Effluent Gross							91	mg/L	N		BAS	ENF
IL0001392	EMERALD POLYMER ADDITIVES LLC	07130001-ILLINOIS RIVER	11/30/2018	001-0	00600-1-0	Nitrogen, total [as N]	Effluent Gross							100	mg/L	N		BAS	ENF
IL0001392	EMERALD POLYMER ADDITIVES LLC	07130001-ILLINOIS RIVER	10/31/2018	001-0	00600-1-0	Nitrogen, total [as N]	Effluent Gross							100	mg/L	N		BAS	ENF
IL0001392	EMERALD POLYMER ADDITIVES LLC	07130001-ILLINOIS RIVER	09/30/2018	001-0	00600-1-0	Nitrogen, total [as N]	Effluent Gross							130	mg/L	N		BAS	ENF
IL0001392	EMERALD POLYMER ADDITIVES LLC	07130001-ILLINOIS RIVER	08/31/2018	001-0	00600-1-0	Nitrogen, total [as N]	Effluent Gross							88	mg/L	N		BAS	ENF
IL0001392	EMERALD POLYMER ADDITIVES LLC	07130001-ILLINOIS RIVER	07/31/2018	001-0	00600-1-0	Nitrogen, total [as N]	Effluent Gross							110	mg/L	N		BAS	ENF
IL0001392	EMERALD POLYMER ADDITIVES LLC	07130001-ILLINOIS RIVER	06/30/2018	001-0	00600-1-0	Nitrogen, total [as N]	Effluent Gross							130	mg/L	N		BAS	ENF
IL0001392	EMERALD POLYMER ADDITIVES LLC	07130001-ILLINOIS RIVER	05/31/2018	001-0	00600-1-0	Nitrogen, total [as N]	Effluent Gross							130	mg/L	N		BAS	ENF
IL0001392	EMERALD POLYMER ADDITIVES LLC	07130001-ILLINOIS RIVER	04/30/2018	001-0	00600-1-0	Nitrogen, total [as N]	Effluent Gross							150	mg/L	N		BAS	ENF
IL0001392	EMERALD POLYMER ADDITIVES LLC	07130001-ILLINOIS RIVER	03/31/2018	001-0	00600-1-0	Nitrogen, total [as N]	Effluent Gross							100	mg/L	N		BAS	ENF
IL0001392	EMERALD POLYMER ADDITIVES LLC	07130001-ILLINOIS RIVER	02/29/2018	001-0	00600-1-0	Nitrogen, total [as N]	Effluent Gross							85	mg/L	N		BAS	ENF
IL0001392	EMERALD POLYMER ADDITIVES LLC	07130001-ILLINOIS RIVER	01/31/2018	001-0	00600-1-0	Nitrogen, total [as N]	Effluent Gross							120	mg/L	N		BAS	ENF
IL0001392	EMERALD POLYMER ADDITIVES LLC	07130001-ILLINOIS RIVER	12/31/2017	001-0	00600-1-0	Nitrogen, total [as N]	Effluent Gross							90	mg/L	N		BAS	ENF
IL0001392	EMERALD POLYMER ADDITIVES LLC	07130001-ILLINOIS RIVER	11/30/2017	001-0	00600-1-0	Nitrogen, total [as N]	Effluent Gross							100	mg/L	N		BAS	ENF
IL0001392	EMERALD POLYMER ADDITIVES LLC	07130001-ILLINOIS RIVER	10/31/2017	001-0	00600-1-0	Nitrogen, total [as N]	Effluent Gross							94	mg/L	N		BAS	ENF
IL0001392	EMERALD POLYMER ADDITIVES LLC	07130001-ILLINOIS RIVER	09/30/2017	001-0	00600-1-0	Nitrogen, total [as N]	Effluent Gross							88	mg/L	N		BAS	ENF
IL0001392	EMERALD POLYMER ADDITIVES LLC	07130001-ILLINOIS RIVER	08/31/2017	001-0	00600-1-0	Nitrogen, total [as N]	Effluent Gross							93	mg/L	N		BAS	ENF
IL0001392	EMERALD POLYMER ADDITIVES LLC	07130001-ILLINOIS RIVER	07/31/2017	001-0	00600-1-0	Nitrogen, total [as N]	Effluent Gross							78	mg/L	N		BAS	ENF
IL0001392	EMERALD POLYMER ADDITIVES LLC	07130001-ILLINOIS RIVER	06/30/2017	001-0	00600-1-0	Nitrogen, total [as N]	Effluent Gross							79	mg/L	N		BAS	ENF
IL0001392	EMERALD POLYMER ADDITIVES LLC	07130001-ILLINOIS RIVER	05/31/2017	001-0	00600-1-0	Nitrogen, total [as N]	Effluent Gross							110	mg/L	N		BAS	ENF
IL0001392	EMERALD POLYMER ADDITIVES LLC	07130001-ILLINOIS RIVER	04/30/2017	001-0	00600-1-0	Nitrogen, total [as N]	Effluent Gross							97	mg/L	N		BAS	ENF
IL0001392	EMERALD POLYMER ADDITIVES LLC	07130001-ILLINOIS RIVER	03/31/2017	001-0	00600-1-0	Nitrogen, total [as N]	Effluent Gross							99	mg/L	N		BAS	ENF
IL0001392	EMERALD POLYMER ADDITIVES LLC	07130001-ILLINOIS RIVER	02/29/2017	001-0	00600-1-0	Nitrogen, total [as N]	Effluent Gross							99	mg/L	N		BAS	ENF
IL0001392	EMERALD POLYMER ADDITIVES LLC	07130001-ILLINOIS RIVER	01/31/2017	001-0	00600-1-0	Nitrogen, total [as N]	Effluent Gross							96	mg/L	N		BAS	ENF
IL0001392	EMERALD POLYMER ADDITIVES LLC	07130001-ILLINOIS RIVER	12/31/2016	001-0	00600-1-0	Nitrogen, total [as N]	Effluent Gross							98	mg/L	N		BAS	ENF
IL0001392	EMERALD POLYMER ADDITIVES LLC	07130001-ILLINOIS RIVER	11/30/2016	001-0	00600-1-0	Nitrogen, total [as N]	Effluent Gross							78	mg/L	N		BAS	ENF
IL0001392	EMERALD POLYMER ADDITIVES LLC	07130001-ILLINOIS RIVER	10/31/2016	001-0	00600-1-0	Nitrogen, total [as N]	Effluent Gross							80	mg/L	N		BAS	ENF
IL0001392	EMERALD POLYMER ADDITIVES LLC	07130001-ILLINOIS RIVER	11/30/2019	001-0	00610-1-0	Nitrogen, ammonia total [as N]	Effluent Gross		56.907	195.936	lb/d		11.975	39	mg/L	N		BAS	ENF
IL0001392	EMERALD POLYMER ADDITIVES LLC	07130001-ILLINOIS RIVER	10/31/2019	001-0	00610-1-0	Nitrogen, ammonia total [as N]	Effluent Gross		21.611	78.536	lb/d		4.308	16	mg/L	N		BAS	ENF



IL0001392	EMERALD POLYMER ADDITIVES LLC	07130001-ILLINOIS RIVER	09/30/2019	001-0	00010-1-0	Nitrogen, ammonia total [as N]	Effluent Gross	129.431	349.508	064	29.025	73	mg/L	N	BAS	ENF
IL0001392	EMERALD POLYMER ADDITIVES LLC	07130001-ILLINOIS RIVER	08/31/2019	001-0	00010-1-0	Nitrogen, ammonia total [as N]	Effluent Gross	230.306	303.561	064	50.075	60	mg/L	N	BAS	ENF
IL0001392	EMERALD POLYMER ADDITIVES LLC	07130001-ILLINOIS RIVER	07/31/2019	001-0	00010-1-0	Nitrogen, ammonia total [as N]	Effluent Gross	166.055	360.641	064	32.478	60	mg/L	N	BAS	ENF
IL0001392	EMERALD POLYMER ADDITIVES LLC	07130001-ILLINOIS RIVER	06/30/2019	001-0	00010-1-0	Nitrogen, ammonia total [as N]	Effluent Gross	43.565	75.549	064	8.342	17	mg/L	N	BAS	ENF
IL0001392	EMERALD POLYMER ADDITIVES LLC	07130001-ILLINOIS RIVER	06/31/2019	001-0	00010-1-0	Nitrogen, ammonia total [as N]	Effluent Gross	340.18	438.816	064	80.762	80	mg/L	N	BAS	ENF
IL0001392	EMERALD POLYMER ADDITIVES LLC	07130001-ILLINOIS RIVER	04/30/2019	001-0	00010-1-0	Nitrogen, ammonia total [as N]	Effluent Gross	359.485	433.527	064	70.409	78	mg/L	N	BAS	ENF
IL0001392	EMERALD POLYMER ADDITIVES LLC	07130001-ILLINOIS RIVER	03/31/2019	001-0	00010-1-0	Nitrogen, ammonia total [as N]	Effluent Gross	307.580	515.747	064	73.762	96	mg/L	N	BAS	ENF
IL0001392	EMERALD POLYMER ADDITIVES LLC	07130001-ILLINOIS RIVER	02/28/2019	001-0	00010-1-0	Nitrogen, ammonia total [as N]	Effluent Gross	339.126	529.739	064	63.75	94	mg/L	N	BAS	ENF
IL0001392	EMERALD POLYMER ADDITIVES LLC	07130001-ILLINOIS RIVER	01/31/2019	001-0	00010-1-0	Nitrogen, ammonia total [as N]	Effluent Gross	218.014	325.728	064	58.602	94	mg/L	N	BAS	ENF
IL0001392	EMERALD POLYMER ADDITIVES LLC	07130001-ILLINOIS RIVER	12/31/2018	001-0	00010-1-0	Nitrogen, ammonia total [as N]	Effluent Gross	299.188	364.063	064	74.773	93	mg/L	N	BAS	ENF
IL0001392	EMERALD POLYMER ADDITIVES LLC	07130001-ILLINOIS RIVER	11/30/2018	001-0	00010-1-0	Nitrogen, ammonia total [as N]	Effluent Gross	352.122	498.828	064	79.478	110	mg/L	N	BAS	ENF
IL0001392	EMERALD POLYMER ADDITIVES LLC	07130001-ILLINOIS RIVER	10/31/2018	001-0	00010-1-0	Nitrogen, ammonia total [as N]	Effluent Gross	398.738	553.357	064	82.067	110	mg/L	N	BAS	ENF
IL0001392	EMERALD POLYMER ADDITIVES LLC	07130001-ILLINOIS RIVER	09/30/2018	001-0	00010-1-0	Nitrogen, ammonia total [as N]	Effluent Gross	429.982	552.39	064	89.605	110	mg/L	N	BAS	ENF
IL0001392	EMERALD POLYMER ADDITIVES LLC	07130001-ILLINOIS RIVER	08/31/2018	001-0	00010-1-0	Nitrogen, ammonia total [as N]	Effluent Gross	330.334	467.305	064	75.211	100	mg/L	N	BAS	ENF
IL0001392	EMERALD POLYMER ADDITIVES LLC	07130001-ILLINOIS RIVER	07/31/2018	001-0	00010-1-0	Nitrogen, ammonia total [as N]	Effluent Gross	390.860	477.084	064	87.304	100	mg/L	N	BAS	ENF
IL0001392	EMERALD POLYMER ADDITIVES LLC	07130001-ILLINOIS RIVER	06/30/2018	001-0	00010-1-0	Nitrogen, ammonia total [as N]	Effluent Gross	353.832	445.332	064	73.81	94	mg/L	N	BAS	ENF
IL0001392	EMERALD POLYMER ADDITIVES LLC	07130001-ILLINOIS RIVER	05/31/2018	001-0	00010-1-0	Nitrogen, ammonia total [as N]	Effluent Gross	335.325	450.41	064	70.522	93	mg/L	N	BAS	ENF
IL0001392	EMERALD POLYMER ADDITIVES LLC	07130001-ILLINOIS RIVER	04/30/2018	001-0	00010-1-0	Nitrogen, ammonia total [as N]	Effluent Gross	274.417	430.243	064	73.318	120	mg/L	N	BAS	ENF
IL0001392	EMERALD POLYMER ADDITIVES LLC	07130001-ILLINOIS RIVER	03/31/2018	001-0	00010-1-0	Nitrogen, ammonia total [as N]	Effluent Gross	367.364	463.058	064	99.333	110	mg/L	N	BAS	ENF
IL0001392	EMERALD POLYMER ADDITIVES LLC	07130001-ILLINOIS RIVER	02/29/2018	001-0	00010-1-0	Nitrogen, ammonia total [as N]	Effluent Gross	284.342	362.403	064	66.25	93	mg/L	N	BAS	ENF
IL0001392	EMERALD POLYMER ADDITIVES LLC	07130001-ILLINOIS RIVER	01/31/2018	001-0	00010-1-0	Nitrogen, ammonia total [as N]	Effluent Gross	303.329	502.310	064	80.727	110	mg/L	N	BAS	ENF
IL0001392	EMERALD POLYMER ADDITIVES LLC	07130001-ILLINOIS RIVER	12/31/2017	001-0	00010-1-0	Nitrogen, ammonia total [as N]	Effluent Gross	263.764	311.898	064	60.624	87	mg/L	N	BAS	ENF
IL0001392	EMERALD POLYMER ADDITIVES LLC	07130001-ILLINOIS RIVER	11/30/2017	001-0	00010-1-0	Nitrogen, ammonia total [as N]	Effluent Gross	281.535	415.458	064	68.904	90	mg/L	N	BAS	ENF
IL0001392	EMERALD POLYMER ADDITIVES LLC	07130001-ILLINOIS RIVER	10/31/2017	001-0	00010-1-0	Nitrogen, ammonia total [as N]	Effluent Gross	369.809	427.604	064	70.043	87	mg/L	N	BAS	ENF
IL0001392	EMERALD POLYMER ADDITIVES LLC	07130001-ILLINOIS RIVER	09/30/2017	001-0	00010-1-0	Nitrogen, ammonia total [as N]	Effluent Gross	268.031	362.658	064	65.48	84	mg/L	N	BAS	ENF
IL0001392	EMERALD POLYMER ADDITIVES LLC	07130001-ILLINOIS RIVER	08/31/2017	001-0	00010-1-0	Nitrogen, ammonia total [as N]	Effluent Gross	247.782	357.801	064	60.435	85	mg/L	N	BAS	ENF
IL0001392	EMERALD POLYMER ADDITIVES LLC	07130001-ILLINOIS RIVER	07/31/2017	001-0	00010-1-0	Nitrogen, ammonia total [as N]	Effluent Gross	169.178	354.576	064	41.5	60	mg/L	N	BAS	ENF
IL0001392	EMERALD POLYMER ADDITIVES LLC	07130001-ILLINOIS RIVER	06/30/2017	001-0	00010-1-0	Nitrogen, ammonia total [as N]	Effluent Gross	164.31	240.882	064	38.81	54	mg/L	N	BAS	ENF
IL0001392	EMERALD POLYMER ADDITIVES LLC	07130001-ILLINOIS RIVER	05/31/2017	001-0	00010-1-0	Nitrogen, ammonia total [as N]	Effluent Gross	347.681	454.265	064	80.695	100	mg/L	N	BAS	ENF
IL0001392	EMERALD POLYMER ADDITIVES LLC	07130001-ILLINOIS RIVER	04/30/2017	001-0	00010-1-0	Nitrogen, ammonia total [as N]	Effluent Gross	308.025	451.521	064	81.429	96	mg/L	N	BAS	ENF
IL0001392	EMERALD POLYMER ADDITIVES LLC	07130001-ILLINOIS RIVER	03/31/2017	001-0	00010-1-0	Nitrogen, ammonia total [as N]	Effluent Gross	385.015	437.54	064	84.318	94	mg/L	N	BAS	ENF
IL0001392	EMERALD POLYMER ADDITIVES LLC	07130001-ILLINOIS RIVER	02/29/2017	001-0	00010-1-0	Nitrogen, ammonia total [as N]	Effluent Gross	131.300	200.408	064	33.66	53	mg/L	N	BAS	ENF
IL0001392	EMERALD POLYMER ADDITIVES LLC	07130001-ILLINOIS RIVER	01/31/2017	001-0	00010-1-0	Nitrogen, ammonia total [as N]	Effluent Gross	76.024	202.891	064	20.03	52	mg/L	N	BAS	ENF
IL0001392	EMERALD POLYMER ADDITIVES LLC	07130001-ILLINOIS RIVER	12/31/2016	001-0	00010-1-0	Nitrogen, ammonia total [as N]	Effluent Gross	185.885	213.906	064	52.19	64	mg/L	N	BAS	ENF
IL0001392	EMERALD POLYMER ADDITIVES LLC	07130001-ILLINOIS RIVER	11/30/2016	001-0	00010-1-0	Nitrogen, ammonia total [as N]	Effluent Gross	133.205	229.99	064	36.207	60	mg/L	N	BAS	ENF
IL0001392	EMERALD POLYMER ADDITIVES LLC	07130001-ILLINOIS RIVER	10/31/2016	001-0	00010-1-0	Nitrogen, ammonia total [as N]	Effluent Gross	298.633	415.789	064	70	60	mg/L	N	BAS	ENF
IL0001392	EMERALD POLYMER ADDITIVES LLC	07130001-ILLINOIS RIVER	09/30/2016	001-0	00010-1-0	Nitrogen, ammonia total [as N]	Effluent Gross		320.244	064	87	mg/L	N	X	BAS	ENF
IL0001392	EMERALD POLYMER ADDITIVES LLC	07130001-ILLINOIS RIVER	08/31/2016	001-0	00010-1-0	Nitrogen, ammonia total [as N]	Effluent Gross		309.765	064	100	mg/L	N	X	BAS	ENF
IL0001392	EMERALD POLYMER ADDITIVES LLC	07130001-ILLINOIS RIVER	07/31/2016	001-0	00010-1-0	Nitrogen, ammonia total [as N]	Effluent Gross		514.8	064	120	mg/L	N	X	BAS	ENF
IL0001392	EMERALD POLYMER ADDITIVES LLC	07130001-ILLINOIS RIVER	06/30/2016	001-0	00010-1-0	Nitrogen, ammonia total [as N]	Effluent Gross		354.516	064	100	mg/L	N	X	BAS	ENF
IL0001392	EMERALD POLYMER ADDITIVES LLC	07130001-ILLINOIS RIVER	05/31/2016	001-0	00010-1-0	Nitrogen, ammonia total [as N]	Effluent Gross		442.411	064	110	mg/L	N	X	BAS	ENF
IL0001392	EMERALD POLYMER ADDITIVES LLC	07130001-ILLINOIS RIVER	04/30/2016	001-0	00010-1-0	Nitrogen, ammonia total [as N]	Effluent Gross		405.09	064	100	mg/L	N	X	BAS	ENF

IL0001392	EMERALD POLYMER ADDITIVES LLC	07130001-ILLINOIS RIVER	02/22/2018	A01-0	00310-J-0	BOD, 5-day, 20 deg. C	Intermediate Treatment, Process Complete	23.529	38.09	lb/d	6.145	9.0	mg/L	N	BAS	ENF
IL0001392	EMERALD POLYMER ADDITIVES LLC	07130001-ILLINOIS RIVER	01/31/2018	A01-0	00310-J-0	BOD, 5-day, 20 deg. C	Intermediate Treatment, Process Complete	22.071	39.35	lb/d	5.864	9	mg/L	N	BAS	ENF
IL0001392	EMERALD POLYMER ADDITIVES LLC	07130001-ILLINOIS RIVER	12/31/2017	A01-0	00310-J-0	BOD, 5-day, 20 deg. C	Intermediate Treatment, Process Complete	18.233	34.954	lb/d	5.186	8.8	mg/L	N	BAS	ENF
IL0001392	EMERALD POLYMER ADDITIVES LLC	07130001-ILLINOIS RIVER	11/30/2017	A01-0	00310-J-0	BOD, 5-day, 20 deg. C	Intermediate Treatment, Process Complete	25.247	61.038	lb/d	6.332	14	mg/L	N	BAS	ENF
IL0001392	EMERALD POLYMER ADDITIVES LLC	07130001-ILLINOIS RIVER	10/31/2017	A01-0	00310-J-0	BOD, 5-day, 20 deg. C	Intermediate Treatment, Process Complete	44.253	101.486	lb/d	9.961	20	mg/L	N	BAS	ENF
IL0001392	EMERALD POLYMER ADDITIVES LLC	07130001-ILLINOIS RIVER	09/30/2017	A01-0	00310-J-0	BOD, 5-day, 20 deg. C	Intermediate Treatment, Process Complete	48.481	103.188	lb/d	11.885	27	mg/L	N	BAS	ENF
IL0001392	EMERALD POLYMER ADDITIVES LLC	07130001-ILLINOIS RIVER	08/31/2017	A01-0	00310-J-0	BOD, 5-day, 20 deg. C	Intermediate Treatment, Process Complete	39.911	89.479	lb/d	9.826	16	mg/L	N	BAS	ENF
IL0001392	EMERALD POLYMER ADDITIVES LLC	07130001-ILLINOIS RIVER	07/31/2017	A01-0	00310-J-0	BOD, 5-day, 20 deg. C	Intermediate Treatment, Process Complete	32.221	57.742	lb/d	8.036	14	mg/L	N	BAS	ENF
IL0001392	EMERALD POLYMER ADDITIVES LLC	07130001-ILLINOIS RIVER	06/30/2017	A01-0	00310-J-0	BOD, 5-day, 20 deg. C	Intermediate Treatment, Process Complete	30.713	64.786	lb/d	7.338	14	mg/L	N	BAS	ENF
IL0001392	EMERALD POLYMER ADDITIVES LLC	07130001-ILLINOIS RIVER	05/31/2017	A01-0	00310-J-0	BOD, 5-day, 20 deg. C	Intermediate Treatment, Process Complete	43.12	79.801	lb/d	9.987	18	mg/L	N	BAS	ENF
IL0001392	EMERALD POLYMER ADDITIVES LLC	07130001-ILLINOIS RIVER	04/30/2017	A01-0	00310-J-0	BOD, 5-day, 20 deg. C	Intermediate Treatment, Process Complete	27.06	51.977	lb/d	6.195	11	mg/L	N	BAS	ENF
IL0001392	EMERALD POLYMER ADDITIVES LLC	07130001-ILLINOIS RIVER	03/31/2017	A01-0	00310-J-0	BOD, 5-day, 20 deg. C	Intermediate Treatment, Process Complete	30.991	88.358	lb/d	7.177	20	mg/L	N	BAS	ENF
IL0001392	EMERALD POLYMER ADDITIVES LLC	07130001-ILLINOIS RIVER	02/28/2017	A01-0	00310-J-0	BOD, 5-day, 20 deg. C	Intermediate Treatment, Process Complete	23.06	75.572	lb/d	5.795	18	mg/L	N	BAS	ENF
IL0001392	EMERALD POLYMER ADDITIVES LLC	07130001-ILLINOIS RIVER	01/31/2017	A01-0	00310-J-0	BOD, 5-day, 20 deg. C	Intermediate Treatment, Process Complete	17.472	37.227	lb/d	5.065	7.7	mg/L	N	BAS	ENF
IL0001392	EMERALD POLYMER ADDITIVES LLC	07130001-ILLINOIS RIVER	12/31/2016	A01-0	00310-J-0	BOD, 5-day, 20 deg. C	Intermediate Treatment, Process Complete	31.578	85.692	lb/d	9.907	22	mg/L	N	BAS	ENF
IL0001392	EMERALD POLYMER ADDITIVES LLC	07130001-ILLINOIS RIVER	11/30/2016	A01-0	00310-J-0	BOD, 5-day, 20 deg. C	Intermediate Treatment, Process Complete	21.57	54.697	lb/d	6.018	14	mg/L	N	BAS	ENF
IL0001392	EMERALD POLYMER ADDITIVES LLC	07130001-ILLINOIS RIVER	10/31/2016	A01-0	00310-J-0	BOD, 5-day, 20 deg. C	Intermediate Treatment, Process Complete	21.926	36.786	lb/d	5.714	8.7	mg/L	N	BAS	ENF
IL0001392	EMERALD POLYMER ADDITIVES LLC	07130001-ILLINOIS RIVER	09/30/2016	A01-0	00310-J-0	BOD, 5-day, 20 deg. C	Intermediate Treatment, Process Complete	20.902	40.755	lb/d	5.824	9.8	mg/L	N	BAS	ENF
IL0001392	EMERALD POLYMER ADDITIVES LLC	07130001-ILLINOIS RIVER	08/31/2016	A01-0	00310-J-0	BOD, 5-day, 20 deg. C	Intermediate Treatment, Process Complete	43.463	126.685	lb/d	11.71	31	mg/L	N	BAS	ENF
IL0001392	EMERALD POLYMER ADDITIVES LLC	07130001-ILLINOIS RIVER	07/31/2016	A01-0	00310-J-0	BOD, 5-day, 20 deg. C	Intermediate Treatment, Process Complete	25.55	45.401	lb/d	6.581	11	mg/L	N	BAS	ENF
IL0001392	EMERALD POLYMER ADDITIVES LLC	07130001-ILLINOIS RIVER	06/30/2016	A01-0	00310-J-0	BOD, 5-day, 20 deg. C	Intermediate Treatment, Process Complete	25.806	73.261	lb/d	6.764	17	mg/L	N	BAS	ENF
IL0001392	EMERALD POLYMER ADDITIVES LLC	07130001-ILLINOIS RIVER	05/31/2016	A01-0	00310-J-0	BOD, 5-day, 20 deg. C	Intermediate Treatment, Process Complete	27.988	49.44	lb/d	7.235	13	mg/L	N	BAS	ENF

IL0001302	EMERALD POLYMER ADDITIVES LLC	07130011-ILLINOIS RIVER	04/08/2018	A01-0	03316-J-0	NOQ 5-ky, 20 deg C	Intermittent Treatment, Process Complete	29.579	60.763	841	7.762	15	ng/L	N	BAS	ENF
IL0001302	EMERALD POLYMER ADDITIVES LLC	07130011-ILLINOIS RIVER	11/08/2019	A01-0	03400-J-0	pH	Intermittent Treatment, Process Complete			ND01A		ND01A	SU	N	BAS	ENF
IL0001302	EMERALD POLYMER ADDITIVES LLC	07130001-ILLINOIS RIVER	10/31/2019	A01-0	03405-J-0	pH	Intermittent Treatment, Process Complete	6.75			6.75	SU	N	BAS	ENF	
IL0001302	EMERALD POLYMER ADDITIVES LLC	07130011-ILLINOIS RIVER	09/02/2019	A01-0	00450-J-0	pH	Intermittent Treatment, Process Complete	7.04			7.04	SU	N	BAS	ENF	
IL0001302	EMERALD POLYMER ADDITIVES LLC	07130001-ILLINOIS RIVER	08/31/2019	A01-0	00450-J-0	pH	Intermittent Treatment, Process Complete	6.94			6.94	SU	N	BAS	ENF	
IL0001302	EMERALD POLYMER ADDITIVES LLC	07130001-ILLINOIS RIVER	07/31/2019	A01-0	00400-J-0	pH	Intermittent Treatment, Process Complete	7			7	SU	N	BAS	ENF	
IL0001302	EMERALD POLYMER ADDITIVES LLC	07130001-ILLINOIS RIVER	06/30/2019	A01-0	00400-J-0	pH	Intermittent Treatment, Process Complete	7.12			7.12	SU	N	BAS	ENF	
IL0001302	EMERALD POLYMER ADDITIVES LLC	07130001-ILLINOIS RIVER	05/31/2019	A01-0	00400-J-0	pH	Intermittent Treatment, Process Complete	6.95			6.95	SU	N	BAS	ENF	
IL0001302	EMERALD POLYMER ADDITIVES LLC	07130001-ILLINOIS RIVER	04/30/2019	A01-0	00400-J-0	pH	Intermittent Treatment, Process Complete	6.9			6.9	SU	N	BAS	ENF	
IL0001302	EMERALD POLYMER ADDITIVES LLC	07130001-ILLINOIS RIVER	03/31/2019	A01-0	00300-J-0	pH	Intermittent Treatment, Process Complete	7.02			7.02	SU	N	BAS	ENF	
IL0001302	EMERALD POLYMER ADDITIVES LLC	07130001-ILLINOIS RIVER	02/28/2019	A01-0	00400-J-0	pH	Intermittent Treatment, Process Complete	6.90			6.90	SU	N	BAS	ENF	
IL0001302	EMERALD POLYMER ADDITIVES LLC	07130001-ILLINOIS RIVER	01/31/2019	A01-0	00400-J-0	pH	Intermittent Treatment, Process Complete	6.85			6.85	SU	N	BAS	ENF	
IL0001302	EMERALD POLYMER ADDITIVES LLC	07130001-ILLINOIS RIVER	12/31/2018	A01-0	00400-J-0	pH	Intermittent Treatment, Process Complete	6.8			6.8	SU	N	BAS	ENF	
IL0001302	EMERALD POLYMER ADDITIVES LLC	07130001-ILLINOIS RIVER	11/30/2018	A01-0	00300-J-0	pH	Intermittent Treatment, Process Complete	6.8			6.8	SU	N	BAS	ENF	
IL0001302	EMERALD POLYMER ADDITIVES LLC	07130001-ILLINOIS RIVER	10/31/2018	A01-0	00400-J-0	pH	Intermittent Treatment, Process Complete	7			7	SU	N	BAS	ENF	
IL0001302	EMERALD POLYMER ADDITIVES LLC	07130001-ILLINOIS RIVER	09/30/2018	A01-0	00400-J-0	pH	Intermittent Treatment, Process Complete	7.02			7.02	SU	N	BAS	ENF	
IL0001302	EMERALD POLYMER ADDITIVES LLC	07130001-ILLINOIS RIVER	08/31/2018	A01-0	00400-J-0	pH	Intermittent Treatment, Process Complete	7.22			7.22	SU	N	BAS	ENF	
IL0001302	EMERALD POLYMER ADDITIVES LLC	07130001-ILLINOIS RIVER	07/31/2018	A01-0	00400-J-0	pH	Intermittent Treatment, Process Complete	7.37			7.37	SU	N	BAS	ENF	
IL0001302	EMERALD POLYMER ADDITIVES LLC	07130001-ILLINOIS RIVER	06/30/2018	A01-0	00400-J-0	pH	Intermittent Treatment, Process Complete	7.4			7.4	SU	N	BAS	ENF	
IL0001302	EMERALD POLYMER ADDITIVES LLC	07130001-ILLINOIS RIVER	05/31/2018	A01-0	00400-J-0	pH	Intermittent Treatment, Process Complete	6.83			6.83	SU	N	BAS	ENF	
IL0001302	EMERALD POLYMER ADDITIVES LLC	07130001-ILLINOIS RIVER	04/30/2018	A01-0	00400-J-0	pH	Intermittent Treatment, Process Complete	6.85			6.85	SU	N	BAS	ENF	
IL0001302	EMERALD POLYMER ADDITIVES LLC	07130001-ILLINOIS RIVER	03/31/2018	A01-0	00400-J-0	pH	Intermittent Treatment, Process Complete	7			7	SU	N	BAS	ENF	

IL0001392	EMERALD POLYMER ADDITIVES LLC	07130001-ILLINOIS RIVER	02/28/2018	A01-0	00400-J-0	pH	Intermediate Treatment, Process Complete				6.95	7.68	SU	N		BAS	ENF
IL0001392	EMERALD POLYMER ADDITIVES LLC	07130001-ILLINOIS RIVER	01/31/2018	A01-0	00400-J-0	pH	Intermediate Treatment, Process Complete				7.25	7.84	SU	N		BAS	ENF
IL0001392	EMERALD POLYMER ADDITIVES LLC	07130001-ILLINOIS RIVER	12/31/2017	A01-0	00400-J-0	pH	Intermediate Treatment, Process Complete				6.74	8	SU	N		BAS	ENF
IL0001392	EMERALD POLYMER ADDITIVES LLC	07130001-ILLINOIS RIVER	11/30/2017	A01-0	00400-J-0	pH	Intermediate Treatment, Process Complete				6.81	7.62	SU	N		BAS	ENF
IL0001392	EMERALD POLYMER ADDITIVES LLC	07130001-ILLINOIS RIVER	10/31/2017	A01-0	00400-J-0	pH	Intermediate Treatment, Process Complete				7.07	7.97	SU	N		BAS	ENF
IL0001392	EMERALD POLYMER ADDITIVES LLC	07130001-ILLINOIS RIVER	09/30/2017	A01-0	00400-J-0	pH	Intermediate Treatment, Process Complete				7.21	8.07	SU	N		BAS	ENF
IL0001392	EMERALD POLYMER ADDITIVES LLC	07130001-ILLINOIS RIVER	08/31/2017	A01-0	00400-J-0	pH	Intermediate Treatment, Process Complete				6.9	8.03	SU	N		BAS	ENF
IL0001392	EMERALD POLYMER ADDITIVES LLC	07130001-ILLINOIS RIVER	07/31/2017	A01-0	00400-J-0	pH	Intermediate Treatment, Process Complete				7	8.1	SU	N		BAS	ENF
IL0001392	EMERALD POLYMER ADDITIVES LLC	07130001-ILLINOIS RIVER	06/30/2017	A01-0	00400-J-0	pH	Intermediate Treatment, Process Complete				6.95	8.03	SU	N		BAS	ENF
IL0001392	EMERALD POLYMER ADDITIVES LLC	07130001-ILLINOIS RIVER	05/31/2017	A01-0	00400-J-0	pH	Intermediate Treatment, Process Complete				6.97	8.08	SU	N		BAS	ENF
IL0001392	EMERALD POLYMER ADDITIVES LLC	07130001-ILLINOIS RIVER	04/30/2017	A01-0	00400-J-0	pH	Intermediate Treatment, Process Complete				7.19	8.09	SU	N		BAS	ENF
IL0001392	EMERALD POLYMER ADDITIVES LLC	07130001-ILLINOIS RIVER	03/31/2017	A01-0	00400-J-0	pH	Intermediate Treatment, Process Complete				6.78	8.31	SU	N		BAS	ENF
IL0001392	EMERALD POLYMER ADDITIVES LLC	07130001-ILLINOIS RIVER	02/28/2017	A01-0	00400-J-0	pH	Intermediate Treatment, Process Complete				6.84	7.52	SU	N		BAS	ENF
IL0001392	EMERALD POLYMER ADDITIVES LLC	07130001-ILLINOIS RIVER	01/31/2017	A01-0	00400-J-0	pH	Intermediate Treatment, Process Complete				7.08	7.72	SU	N		BAS	ENF
IL0001392	EMERALD POLYMER ADDITIVES LLC	07130001-ILLINOIS RIVER	12/31/2016	A01-0	00400-J-0	pH	Intermediate Treatment, Process Complete				7.1	8.18	SU	N		BAS	ENF
IL0001392	EMERALD POLYMER ADDITIVES LLC	07130001-ILLINOIS RIVER	11/30/2016	A01-0	00400-J-0	pH	Intermediate Treatment, Process Complete				7.19	7.67	SU	N		BAS	ENF
IL0001392	EMERALD POLYMER ADDITIVES LLC	07130001-ILLINOIS RIVER	10/31/2016	A01-0	00400-J-0	pH	Intermediate Treatment, Process Complete				7.03	8.01	SU	N		BAS	ENF
IL0001392	EMERALD POLYMER ADDITIVES LLC	07130001-ILLINOIS RIVER	09/30/2016	A01-0	00400-J-0	pH	Intermediate Treatment, Process Complete				7.28	7.79	SU	N		BAS	ENF
IL0001392	EMERALD POLYMER ADDITIVES LLC	07130001-ILLINOIS RIVER	08/31/2016	A01-0	00400-J-0	pH	Intermediate Treatment, Process Complete				7.23	7.67	SU	N		BAS	ENF
IL0001392	EMERALD POLYMER ADDITIVES LLC	07130001-ILLINOIS RIVER	07/31/2016	A01-0	00400-J-0	pH	Intermediate Treatment, Process Complete				7.25	8.1	SU	N		BAS	ENF
IL0001392	EMERALD POLYMER ADDITIVES LLC	07130001-ILLINOIS RIVER	06/30/2016	A01-0	00400-J-0	pH	Intermediate Treatment, Process Complete				7.23	7.82	SU	N		BAS	ENF
IL0001392	EMERALD POLYMER ADDITIVES LLC	07130001-ILLINOIS RIVER	05/31/2016	A01-0	00400-J-0	pH	Intermediate Treatment, Process Complete				7.17	7.71	SU	N		BAS	ENF

IL0001392	EMERALD POLYMER ADDITIVES LLC	07130001-ILLINOIS RIVER	02/26/2018	A01-0	00530-J-0	Solids, total suspended	Intermediate Treatment, Process Complete		81.511	95.244	lb/d		15.95	21	mg/L	N	BAS	ENF
IL0001392	EMERALD POLYMER ADDITIVES LLC	07130001-ILLINOIS RIVER	01/31/2018	A01-0	00530-J-0	Solids, total suspended	Intermediate Treatment, Process Complete		92.43	105.967	lb/d		24.384	42	mg/L	N	BAS	ENF
IL0001392	EMERALD POLYMER ADDITIVES LLC	07130001-ILLINOIS RIVER	12/31/2017	A01-0	00530-J-0	Solids, total suspended	Intermediate Treatment, Process Complete		64.496	147.741	lb/d		18.607	43	mg/L	N	BAS	ENF
IL0001392	EMERALD POLYMER ADDITIVES LLC	07130001-ILLINOIS RIVER	11/30/2017	A01-0	00530-J-0	Solids, total suspended	Intermediate Treatment, Process Complete		85.964	138.147	lb/d		22	32	mg/L	N	BAS	ENF
IL0001392	EMERALD POLYMER ADDITIVES LLC	07130001-ILLINOIS RIVER	10/31/2017	A01-0	00530-J-0	Solids, total suspended	Intermediate Treatment, Process Complete		92.049	145.704	lb/d		20.678	32	mg/L	N	BAS	ENF
IL0001392	EMERALD POLYMER ADDITIVES LLC	07130001-ILLINOIS RIVER	09/30/2017	A01-0	00530-J-0	Solids, total suspended	Intermediate Treatment, Process Complete		69.014	207.164	lb/d		23.79	48	mg/L	N	BAS	ENF
IL0001392	EMERALD POLYMER ADDITIVES LLC	07130001-ILLINOIS RIVER	08/31/2017	A01-0	00530-J-0	Solids, total suspended	Intermediate Treatment, Process Complete		64.803	187.838	lb/d		16.27	46	mg/L	N	BAS	ENF
IL0001392	EMERALD POLYMER ADDITIVES LLC	07130001-ILLINOIS RIVER	07/31/2017	A01-0	00530-J-0	Solids, total suspended	Intermediate Treatment, Process Complete		25.80	53.511	lb/d		6.355	13	mg/L	N	BAS	ENF
IL0001392	EMERALD POLYMER ADDITIVES LLC	07130001-ILLINOIS RIVER	06/30/2017	A01-0	00530-J-0	Solids, total suspended	Intermediate Treatment, Process Complete		25.198	44.974	lb/d		5.924	10	mg/L	N	BAS	ENF
IL0001392	EMERALD POLYMER ADDITIVES LLC	07130001-ILLINOIS RIVER	05/31/2017	A01-0	00530-J-0	Solids, total suspended	Intermediate Treatment, Process Complete		34.58	88.07	lb/d		7.991	19	mg/L	N	BAS	ENF
IL0001392	EMERALD POLYMER ADDITIVES LLC	07130001-ILLINOIS RIVER	04/30/2017	A01-0	00530-J-0	Solids, total suspended	Intermediate Treatment, Process Complete		74.238	180.377	lb/d		16.552	41	mg/L	N	BAS	ENF
IL0001392	EMERALD POLYMER ADDITIVES LLC	07130001-ILLINOIS RIVER	03/31/2017	A01-0	00530-J-0	Solids, total suspended	Intermediate Treatment, Process Complete		28.035	55.321	lb/d		6.391	11	mg/L	N	BAS	ENF
IL0001392	EMERALD POLYMER ADDITIVES LLC	07130001-ILLINOIS RIVER	02/28/2017	A01-0	00530-J-0	Solids, total suspended	Intermediate Treatment, Process Complete		31.82	60.962	lb/d		8.17	18	mg/L	N	BAS	ENF
IL0001392	EMERALD POLYMER ADDITIVES LLC	07130001-ILLINOIS RIVER	01/31/2017	A01-0	00530-J-0	Solids, total suspended	Intermediate Treatment, Process Complete		23.068	48.92	lb/d		6.791	13	mg/L	N	BAS	ENF
IL0001392	EMERALD POLYMER ADDITIVES LLC	07130001-ILLINOIS RIVER	12/31/2016	A01-0	00530-J-0	Solids, total suspended	Intermediate Treatment, Process Complete		30.374	104.706	lb/d		9.171	33	mg/L	N	BAS	ENF
IL0001392	EMERALD POLYMER ADDITIVES LLC	07130001-ILLINOIS RIVER	11/30/2016	A01-0	00530-J-0	Solids, total suspended	Intermediate Treatment, Process Complete		31.016	69.276	lb/d		8.75	20	mg/L	N	BAS	ENF
IL0001392	EMERALD POLYMER ADDITIVES LLC	07130001-ILLINOIS RIVER	10/31/2016	A01-0	00530-J-0	Solids, total suspended	Intermediate Treatment, Process Complete		21.913	49.886	lb/d		5.573	11	mg/L	N	BAS	ENF
IL0001392	EMERALD POLYMER ADDITIVES LLC	07130001-ILLINOIS RIVER	09/30/2016	A01-0	00530-J-0	Solids, total suspended	Intermediate Treatment, Process Complete		18.654	39.024	lb/d		5.162	9.6	mg/L	N	BAS	ENF
IL0001392	EMERALD POLYMER ADDITIVES LLC	07130001-ILLINOIS RIVER	08/31/2016	A01-0	00530-J-0	Solids, total suspended	Intermediate Treatment, Process Complete		21.91	40.496	lb/d		6.06	10	mg/L	N	BAS	ENF
IL0001392	EMERALD POLYMER ADDITIVES LLC	07130001-ILLINOIS RIVER	07/31/2016	A01-0	00530-J-0	Solids, total suspended	Intermediate Treatment, Process Complete		28.326	50.256	lb/d		7.276	12	mg/L	N	BAS	ENF
IL0001392	EMERALD POLYMER ADDITIVES LLC	07130001-ILLINOIS RIVER	06/30/2016	A01-0	00530-J-0	Solids, total suspended	Intermediate Treatment, Process Complete		38.463	74.091	lb/d		10.309	22	mg/L	N	BAS	ENF
IL0001392	EMERALD POLYMER ADDITIVES LLC	07130001-ILLINOIS RIVER	05/31/2016	A01-0	00530-J-0	Solids, total suspended	Intermediate Treatment, Process Complete	34	126.128	282.466	lb/d		32.496	67	mg/L	Y	BAS	ENF

IL0001392	EMERALD POLYMER ADDITIVES LLC	07130001-ILLINOIS RIVER	08/31/2018	A01-0	34423-J-0	Methylene chloride	Intermediate Treatment, Process Complete	.004	.004	lb/d		.001	.001	mg/L	N		BAS	ENF
IL0001392	EMERALD POLYMER ADDITIVES LLC	07130001-ILLINOIS RIVER	07/31/2018	A01-0	34423-J-0	Methylene chloride	Intermediate Treatment, Process Complete	.004	.004	lb/d		.001	.001	mg/L	N		BAS	ENF
IL0001392	EMERALD POLYMER ADDITIVES LLC	07130001-ILLINOIS RIVER	08/30/2018	A01-0	34423-J-0	Methylene chloride	Intermediate Treatment, Process Complete	.004	.004	lb/d		.001	.001	mg/L	N		BAS	ENF
IL0001392	EMERALD POLYMER ADDITIVES LLC	07130001-ILLINOIS RIVER	05/31/2018	A01-0	34423-J-0	Methylene chloride	Intermediate Treatment, Process Complete	.004	.004	lb/d		.001	.001	mg/L	N		BAS	ENF
IL0001392	EMERALD POLYMER ADDITIVES LLC	07130001-ILLINOIS RIVER	04/30/2018	A01-0	34423-J-0	Methylene chloride	Intermediate Treatment, Process Complete	.004	.004	lb/d		.001	.001	mg/L	N		BAS	ENF
IL0001392	EMERALD POLYMER ADDITIVES LLC	07130001-ILLINOIS RIVER	11/30/2019	A01-0	50050-J-0	Flow, in conduit or thru treatment plant	Intermediate Treatment, Process Complete	NODI A	NODI A	MGD					N		BAS	ENF
IL0001392	EMERALD POLYMER ADDITIVES LLC	07130001-ILLINOIS RIVER	10/31/2019	A01-0	50050-J-0	Flow, in conduit or thru treatment plant	Intermediate Treatment, Process Complete	.6	.74	MGD					N		BAS	ENF
IL0001392	EMERALD POLYMER ADDITIVES LLC	07130001-ILLINOIS RIVER	09/30/2019	A01-0	50050-J-0	Flow, in conduit or thru treatment plant	Intermediate Treatment, Process Complete	.589	.782	MGD					N		BAS	ENF
IL0001392	EMERALD POLYMER ADDITIVES LLC	07130001-ILLINOIS RIVER	08/31/2019	A01-0	50050-J-0	Flow, in conduit or thru treatment plant	Intermediate Treatment, Process Complete	.553	.677	MGD					N		BAS	ENF
IL0001392	EMERALD POLYMER ADDITIVES LLC	07130001-ILLINOIS RIVER	07/31/2019	A01-0	50050-J-0	Flow, in conduit or thru treatment plant	Intermediate Treatment, Process Complete	.809	.723	MGD					N		BAS	ENF
IL0001392	EMERALD POLYMER ADDITIVES LLC	07130001-ILLINOIS RIVER	06/30/2019	A01-0	50050-J-0	Flow, in conduit or thru treatment plant	Intermediate Treatment, Process Complete	.633	.729	MGD					N		BAS	ENF
IL0001392	EMERALD POLYMER ADDITIVES LLC	07130001-ILLINOIS RIVER	05/31/2019	A01-0	50050-J-0	Flow, in conduit or thru treatment plant	Intermediate Treatment, Process Complete	.678	.784	MGD					N		BAS	ENF
IL0001392	EMERALD POLYMER ADDITIVES LLC	07130001-ILLINOIS RIVER	04/30/2019	A01-0	50050-J-0	Flow, in conduit or thru treatment plant	Intermediate Treatment, Process Complete	.611	.685	MGD					N		BAS	ENF
IL0001392	EMERALD POLYMER ADDITIVES LLC	07130001-ILLINOIS RIVER	03/31/2019	A01-0	50050-J-0	Flow, in conduit or thru treatment plant	Intermediate Treatment, Process Complete	.638	.74	MGD					N		BAS	ENF
IL0001392	EMERALD POLYMER ADDITIVES LLC	07130001-ILLINOIS RIVER	02/28/2019	A01-0	50050-J-0	Flow, in conduit or thru treatment plant	Intermediate Treatment, Process Complete	.597	.72	MGD					N		BAS	ENF
IL0001392	EMERALD POLYMER ADDITIVES LLC	07130001-ILLINOIS RIVER	01/31/2019	A01-0	50050-J-0	Flow, in conduit or thru treatment plant	Intermediate Treatment, Process Complete	.45	.577	MGD					N		BAS	ENF
IL0001392	EMERALD POLYMER ADDITIVES LLC	07130001-ILLINOIS RIVER	12/31/2018	A01-0	50050-J-0	Flow, in conduit or thru treatment plant	Intermediate Treatment, Process Complete	.484	.623	MGD					N		BAS	ENF
IL0001392	EMERALD POLYMER ADDITIVES LLC	07130001-ILLINOIS RIVER	11/30/2018	A01-0	50050-J-0	Flow, in conduit or thru treatment plant	Intermediate Treatment, Process Complete	.525	.638	MGD					N		BAS	ENF
IL0001392	EMERALD POLYMER ADDITIVES LLC	07130001-ILLINOIS RIVER	10/31/2018	A01-0	50050-J-0	Flow, in conduit or thru treatment plant	Intermediate Treatment, Process Complete	.587	.654	MGD					N		BAS	ENF
IL0001392	EMERALD POLYMER ADDITIVES LLC	07130001-ILLINOIS RIVER	09/30/2018	A01-0	50050-J-0	Flow, in conduit or thru treatment plant	Intermediate Treatment, Process Complete	.58	.631	MGD					N		BAS	ENF
IL0001392	EMERALD POLYMER ADDITIVES LLC	07130001-ILLINOIS RIVER	08/31/2018	A01-0	50050-J-0	Flow, in conduit or thru treatment plant	Intermediate Treatment, Process Complete	.34	.616	MGD					N		BAS	ENF
IL0001392	EMERALD POLYMER ADDITIVES LLC	07130001-ILLINOIS RIVER	07/31/2018	A01-0	50050-J-0	Flow, in conduit or thru treatment plant	Intermediate Treatment, Process Complete	.551	.576	MGD					N		BAS	ENF

IL0001382	EMERALD POLYMER ADDITIVES LLC	0713001-ILLINOIS RIVER	06/30/2018	A01-0	50050-J-0	Flow, in conduct or thru treatment plant	Intermediate Treatment Process Complete	58	684	MGD	N	BAS	ENF
IL0001382	EMERALD POLYMER ADDITIVES LLC	0713001-ILLINOIS RIVER	05/31/2018	A01-0	50050-J-0	Flow, in conduct or thru treatment plant	Intermediate Treatment Process Complete	57	598	MGD	N	BAS	ENF
IL0001392	EMERALD POLYMER ADDITIVES LLC	0713001-ILLINOIS RIVER	04/30/2018	A01-0	50050-J-0	Flow, in conduct or thru treatment plant	Intermediate Treatment Process Complete	152	519	MGD	N	BAS	ENF
IL0001392	EMERALD POLYMER ADDITIVES LLC	0713001-ILLINOIS RIVER	03/12/2018	A01-0	50050-J-0	Flow, in conduct or thru treatment plant	Intermediate Treatment Process Complete	131	54	MGD	N	BAS	ENF
IL0001392	EMERALD POLYMER ADDITIVES LLC	0713001-ILLINOIS RIVER	02/28/2018	A01-0	50050-J-0	Flow, in conduct or thru treatment plant	Intermediate Treatment Process Complete	486	571	MGD	N	BAS	ENF
IL0001392	EMERALD POLYMER ADDITIVES LLC	0713001-ILLINOIS RIVER	01/31/2018	A01-0	50050-J-0	Flow, in conduct or thru treatment plant	Intermediate Treatment Process Complete	486	579	MGD	N	BAS	ENF
IL0001392	EMERALD POLYMER ADDITIVES LLC	0713001-ILLINOIS RIVER	12/31/2017	A01-0	50050-J-0	Flow, in conduct or thru treatment plant	Intermediate Treatment Process Complete	404	583	MGD	N	BAS	ENF
IL0001392	EMERALD POLYMER ADDITIVES LLC	0713001-ILLINOIS RIVER	11/30/2017	A01-0	50050-J-0	Flow, in conduct or thru treatment plant	Intermediate Treatment Process Complete	409	579	MGD	N	BAS	ENF
IL0001392	EMERALD POLYMER ADDITIVES LLC	0713001-ILLINOIS RIVER	10/31/2017	A01-0	50050-J-0	Flow, in conduct or thru treatment plant	Intermediate Treatment Process Complete	526	614	MGD	N	BAS	ENF
IL0001392	EMERALD POLYMER ADDITIVES LLC	0713001-ILLINOIS RIVER	09/30/2017	A01-0	50050-J-0	Flow, in conduct or thru treatment plant	Intermediate Treatment Process Complete	183	573	MGD	N	BAS	ENF
IL0001392	EMERALD POLYMER ADDITIVES LLC	0713001-ILLINOIS RIVER	08/31/2017	A01-0	50050-J-0	Flow, in conduct or thru treatment plant	Intermediate Treatment Process Complete	49	628	MGD	N	BAS	ENF
IL0001392	EMERALD POLYMER ADDITIVES LLC	0713001-ILLINOIS RIVER	07/31/2017	A01-0	50050-J-0	Flow, in conduct or thru treatment plant	Intermediate Treatment Process Complete	488	626	MGD	N	BAS	ENF
IL0001392	EMERALD POLYMER ADDITIVES LLC	0713001-ILLINOIS RIVER	06/30/2017	A01-0	50050-J-0	Flow, in conduct or thru treatment plant	Intermediate Treatment Process Complete	515	575	MGD	N	BAS	ENF
IL0001392	EMERALD POLYMER ADDITIVES LLC	0713001-ILLINOIS RIVER	05/31/2017	A01-0	50050-J-0	Flow, in conduct or thru treatment plant	Intermediate Treatment Process Complete	515	596	MGD	N	BAS	ENF
IL0001392	EMERALD POLYMER ADDITIVES LLC	0713001-ILLINOIS RIVER	04/30/2017	A01-0	50050-J-0	Flow, in conduct or thru treatment plant	Intermediate Treatment Process Complete	542	715	MGD	N	BAS	ENF
IL0001392	EMERALD POLYMER ADDITIVES LLC	0713001-ILLINOIS RIVER	03/31/2017	A01-0	50050-J-0	Flow, in conduct or thru treatment plant	Intermediate Treatment Process Complete	518	615	MGD	N	BAS	ENF
IL0001392	EMERALD POLYMER ADDITIVES LLC	0713001-ILLINOIS RIVER	02/29/2017	A01-0	50050-J-0	Flow, in conduct or thru treatment plant	Intermediate Treatment Process Complete	478	539	MGD	N	BAS	ENF
IL0001392	EMERALD POLYMER ADDITIVES LLC	0713001-ILLINOIS RIVER	01/31/2017	A01-0	50050-J-0	Flow, in conduct or thru treatment plant	Intermediate Treatment Process Complete	398	58	MGD	N	BAS	ENF
IL0001392	EMERALD POLYMER ADDITIVES LLC	0713001-ILLINOIS RIVER	12/31/2016	A01-0	50050-J-0	Flow, in conduct or thru treatment plant	Intermediate Treatment Process Complete	466	523	MGD	N	BAS	ENF
IL0001392	EMERALD POLYMER ADDITIVES LLC	0713001-ILLINOIS RIVER	11/30/2016	A01-0	50050-J-0	Flow, in conduct or thru treatment plant	Intermediate Treatment Process Complete	429	636	MGD	N	BAS	ENF
IL0001392	EMERALD POLYMER ADDITIVES LLC	0713001-ILLINOIS RIVER	10/31/2016	A01-0	50050-J-0	Flow, in conduct or thru treatment plant	Intermediate Treatment Process Complete	458	547	MGD	N	BAS	ENF
IL0001392	EMERALD POLYMER ADDITIVES LLC	0713001-ILLINOIS RIVER	09/30/2016	A01-0	50050-J-0	Flow, in conduct or thru treatment plant	Intermediate Treatment Process Complete	129	512	MGD	N	BAS	ENF

IL0001392	EMERALD POLYMER ADDITIVES LLC	07130001-ILLINOIS RIVER	08/31/2018	A01-0	50050-J-0	Flow, in conduit or thru treatment plant	Intermediate Treatment, Process Complete		.440	.628	MGD				N		BAS	ENF
IL0001392	EMERALD POLYMER ADDITIVES LLC	07130001-ILLINOIS RIVER	07/31/2018	A01-0	50050-J-0	Flow, in conduit or thru treatment plant	Intermediate Treatment, Process Complete		.806	.519	MGD				N		BAS	ENF
IL0001392	EMERALD POLYMER ADDITIVES LLC	07130001-ILLINOIS RIVER	06/30/2018	A01-0	50050-J-0	Flow, in conduit or thru treatment plant	Intermediate Treatment, Process Complete		.456	.517	MGD				N		BAS	ENF
IL0001392	EMERALD POLYMER ADDITIVES LLC	07130001-ILLINOIS RIVER	05/31/2018	A01-0	50050-J-0	Flow, in conduit or thru treatment plant	Intermediate Treatment, Process Complete		.467	.521	MGD				N		BAS	ENF
IL0001392	EMERALD POLYMER ADDITIVES LLC	07130001-ILLINOIS RIVER	04/30/2018	A01-0	50050-J-0	Flow, in conduit or thru treatment plant	Intermediate Treatment, Process Complete		.455	.488	MGD				N		BAS	ENF
IL0001392	EMERALD POLYMER ADDITIVES LLC	07130001-ILLINOIS RIVER	11/30/2019	A01-0	74055-J-0	Coliform, fecal general	Intermediate Treatment, Process Complete						NODIA	#/100mL	N		BAS	ENF
IL0001392	EMERALD POLYMER ADDITIVES LLC	07130001-ILLINOIS RIVER	10/31/2019	A01-0	74055-J-0	Coliform, fecal general	Intermediate Treatment, Process Complete						12.2	#/100mL	N		BAS	ENF
IL0001392	EMERALD POLYMER ADDITIVES LLC	07130011-ILLINOIS RIVER	09/30/2019	A01-0	74055-J-0	Coliform, fecal general	Intermediate Treatment, Process Complete						214	#/100mL	N		BAS	ENF
IL0001392	EMERALD POLYMER ADDITIVES LLC	07130011-ILLINOIS RIVER	08/31/2019	A01-0	74055-J-0	Coliform, fecal general	Intermediate Treatment, Process Complete						225	#/100mL	N		BAS	ENF
IL0001392	EMERALD POLYMER ADDITIVES LLC	07130011-ILLINOIS RIVER	07/31/2019	A01-0	74055-J-0	Coliform, fecal general	Intermediate Treatment, Process Complete						20	#/100mL	N		BAS	ENF
IL0001392	EMERALD POLYMER ADDITIVES LLC	07130011-ILLINOIS RIVER	06/30/2019	A01-0	74055-J-0	Coliform, fecal general	Intermediate Treatment, Process Complete						19.7	#/100mL	N		BAS	ENF
IL0001392	EMERALD POLYMER ADDITIVES LLC	07130011-ILLINOIS RIVER	05/31/2019	A01-0	74055-J-0	Coliform, fecal general	Intermediate Treatment, Process Complete						185	#/100mL	N		BAS	ENF
IL0001392	EMERALD POLYMER ADDITIVES LLC	07130011-ILLINOIS RIVER	04/30/2019	A01-0	74055-J-0	Coliform, fecal general	Intermediate Treatment, Process Complete						150	#/100mL	N		BAS	ENF
IL0001392	EMERALD POLYMER ADDITIVES LLC	07130001-ILLINOIS RIVER	03/31/2018	A01-0	74055-J-0	Coliform, fecal general	Intermediate Treatment, Process Complete	14000					80000	#/100mL	Y		BAS	ENF
IL0001392	EMERALD POLYMER ADDITIVES LLC	07130001-ILLINOIS RIVER	02/28/2018	A01-0	74055-J-0	Coliform, fecal general	Intermediate Treatment, Process Complete						< 10	#/100mL	N		BAS	ENF
IL0001392	EMERALD POLYMER ADDITIVES LLC	07130001-ILLINOIS RIVER	01/31/2018	A01-0	74055-J-0	Coliform, fecal general	Intermediate Treatment, Process Complete						< 10	#/100mL	N		BAS	ENF
IL0001392	EMERALD POLYMER ADDITIVES LLC	07130001-ILLINOIS RIVER	12/31/2018	A01-0	74055-J-0	Coliform, fecal general	Intermediate Treatment, Process Complete						< 10	#/100mL	N		BAS	ENF
IL0001392	EMERALD POLYMER ADDITIVES LLC	07130001-ILLINOIS RIVER	11/30/2018	A01-0	74055-J-0	Coliform, fecal general	Intermediate Treatment, Process Complete						< 10	#/100mL	N		BAS	ENF
IL0001392	EMERALD POLYMER ADDITIVES LLC	07130001-ILLINOIS RIVER	10/31/2018	A01-0	74055-J-0	Coliform, fecal general	Intermediate Treatment, Process Complete	1400					6000	#/100mL	Y		BAS	ENF
IL0001392	EMERALD POLYMER ADDITIVES LLC	07130001-ILLINOIS RIVER	09/30/2018	A01-0	74055-J-0	Coliform, fecal general	Intermediate Treatment, Process Complete	325					1700	#/100mL	Y		BAS	ENF
IL0001392	EMERALD POLYMER ADDITIVES LLC	07130001-ILLINOIS RIVER	08/31/2018	A01-0	74055-J-0	Coliform, fecal general	Intermediate Treatment, Process Complete	99999					> 80000	#/100mL	Y		BAS	ENF
IL0001392	EMERALD POLYMER ADDITIVES LLC	07130001-ILLINOIS RIVER	07/31/2018	A01-0	74055-J-0	Coliform, fecal general	Intermediate Treatment, Process Complete	99999					> 80000	#/100mL	Y		BAS	ENF

IL0001392	EMERALD POLYMER ADDITIVES LLC	07130001-ILLINOIS RIVER	08/31/2018	A01-0	74055-J-0	Coliform, fecal general	Intermediate Treatment, Process Complete					340	#/100mL	N		BAS	ENF
IL0001392	EMERALD POLYMER ADDITIVES LLC	07130001-ILLINOIS RIVER	07/31/2018	A01-0	74055-J-0	Coliform, fecal general	Intermediate Treatment, Process Complete	3				410	#/100mL	Y		BAS	ENF
IL0001392	EMERALD POLYMER ADDITIVES LLC	07130001-ILLINOIS RIVER	06/30/2018	A01-0	74055-J-0	Coliform, fecal general	Intermediate Treatment, Process Complete	14900				60000	#/100mL	Y		BAS	ENF
IL0001392	EMERALD POLYMER ADDITIVES LLC	07130001-ILLINOIS RIVER	05/31/2018	A01-0	74055-J-0	Coliform, fecal general	Intermediate Treatment, Process Complete	3400				14000	#/100mL	Y		BAS	ENF
IL0001392	EMERALD POLYMER ADDITIVES LLC	07130001-ILLINOIS RIVER	04/30/2018	A01-0	74065-J-0	Coliform, fecal general	Intermediate Treatment, Process Complete					10	#/100mL	N		BAS	ENF
IL0001392	EMERALD POLYMER ADDITIVES LLC	07130001-ILLINOIS RIVER	03/31/2019	A01-A	00720-J-0	Cyanide, total [as CN]	Intermediate Treatment, Process Complete	.179	.179	ibid	.03	.03	mg/L	N		BAS	ENF
IL0001392	EMERALD POLYMER ADDITIVES LLC	07130001-ILLINOIS RIVER	03/31/2018	A01-A	00720-J-0	Cyanide, total [as CN]	Intermediate Treatment, Process Complete	.050	.050	ibid	.014	.014	mg/L	N		BAS	ENF
IL0001392	EMERALD POLYMER ADDITIVES LLC	07130001-ILLINOIS RIVER	03/31/2017	A01-A	00720-J-0	Cyanide, total [as CN]	Intermediate Treatment, Process Complete	.078	.078	ibid	.018	.018	mg/L	N		BAS	ENF
IL0001392	EMERALD POLYMER ADDITIVES LLC	07130001-ILLINOIS RIVER	03/31/2019	A01-A	01034-J-0	Chromium, total [as Cr]	Intermediate Treatment, Process Complete	< .024	< .024	ibid	< .004	< .004	mg/L	N		BAS	ENF
IL0001392	EMERALD POLYMER ADDITIVES LLC	07130001-ILLINOIS RIVER	03/31/2018	A01-A	01034-J-0	Chromium, total [as Cr]	Intermediate Treatment, Process Complete	< .017	< .017	ibid	< .004	< .004	mg/L	N		BAS	ENF
IL0001392	EMERALD POLYMER ADDITIVES LLC	07130001-ILLINOIS RIVER	03/31/2017	A01-A	01034-J-0	Chromium, total [as Cr]	Intermediate Treatment, Process Complete	< .017	< .017	ibid	< .004	< .004	mg/L	N		BAS	ENF
IL0001392	EMERALD POLYMER ADDITIVES LLC	07130001-ILLINOIS RIVER	03/31/2019	A01-A	01042-J-0	Copper, total [as Cu]	Intermediate Treatment, Process Complete	< .179		ibid	< .03		mg/L	N		BAS	ENF
IL0001392	EMERALD POLYMER ADDITIVES LLC	07130001-ILLINOIS RIVER	03/31/2018	A01-A	01042-J-0	Copper, total [as Cu]	Intermediate Treatment, Process Complete	< .126		ibid	< .03		mg/L	N		BAS	ENF
IL0001392	EMERALD POLYMER ADDITIVES LLC	07130001-ILLINOIS RIVER	03/31/2017	A01-A	01042-J-0	Copper, total [as Cu]	Intermediate Treatment, Process Complete	< .131		ibid	< .03		mg/L	N		BAS	ENF
IL0001392	EMERALD POLYMER ADDITIVES LLC	07130001-ILLINOIS RIVER	03/31/2019	A01-A	01051-J-0	Lead, total [as Pb]	Intermediate Treatment, Process Complete	< .06	< .06	ibid	< .01	< .01	mg/L	N		BAS	ENF
IL0001392	EMERALD POLYMER ADDITIVES LLC	07130001-ILLINOIS RIVER	03/31/2018	A01-A	01051-J-0	Lead, total [as Pb]	Intermediate Treatment, Process Complete	< .042	< .042	ibid	< .01	< .01	mg/L	N		BAS	ENF
IL0001392	EMERALD POLYMER ADDITIVES LLC	07130001-ILLINOIS RIVER	03/31/2017	A01-A	01051-J-0	Lead, total [as Pb]	Intermediate Treatment, Process Complete	< .044	< .044	ibid	< .01	< .01	mg/L	N		BAS	ENF
IL0001392	EMERALD POLYMER ADDITIVES LLC	07130001-ILLINOIS RIVER	03/31/2019	A01-A	01067-J-0	Nickel, total [as Ni]	Intermediate Treatment, Process Complete	< .06	< .06	ibid	< .01	< .01	mg/L	N		BAS	ENF
IL0001392	EMERALD POLYMER ADDITIVES LLC	07130001-ILLINOIS RIVER	03/31/2018	A01-A	01067-J-0	Nickel, total [as Ni]	Intermediate Treatment, Process Complete	< .042	< .042	ibid	< .01	< .01	mg/L	N		BAS	ENF
IL0001392	EMERALD POLYMER ADDITIVES LLC	07130001-ILLINOIS RIVER	03/31/2017	A01-A	01067-J-0	Nickel, total [as Ni]	Intermediate Treatment, Process Complete	< .044	< .044	ibid	< .01	< .01	mg/L	N		BAS	ENF
IL0001392	EMERALD POLYMER ADDITIVES LLC	07130001-ILLINOIS RIVER	03/31/2019	A01-A	01092-J-0	Zinc, total [as Zn]	Intermediate Treatment, Process Complete	< .06	< .06	ibid	< .01	< .01	mg/L	N		BAS	ENF
IL0001392	EMERALD POLYMER ADDITIVES LLC	07130001-ILLINOIS RIVER	03/31/2018	A01-A	01092-J-0	Zinc, total [as Zn]	Intermediate Treatment, Process Complete	.046	.046	ibid	.011	.011	mg/L	N		BAS	ENF

IL0001392	EMERALD POLYMER ADDITIVES LLC	07130001-ILLINOIS RIVER	03/31/2017	A01-A	01092-J-0	Zinc, total [as Zn]	Intermediate Treatment, Process Complete	< 0.44	< 0.44	lbg	< 0.1	< 0.1	mg/L	N	BAS	ENF
IL0001392	EMERALD POLYMER ADDITIVES LLC	07130001-ILLINOIS RIVER	03/31/2019	A01-A	32102-J-0	Carbon tetrachloride	Intermediate Treatment, Process Complete	< 0.03	< 0.03	lbg	< 0.005	< 0.005	mg/L	N	BAS	ENF
IL0001392	EMERALD POLYMER ADDITIVES LLC	07130001-ILLINOIS RIVER	03/31/2018	A01-A	32102-J-0	Carbon tetrachloride	Intermediate Treatment, Process Complete	< 0.21	< 0.21	lbg	< 0.005	< 0.005	mg/L	N	BAS	ENF
IL0001392	EMERALD POLYMER ADDITIVES LLC	07130001-ILLINOIS RIVER	03/31/2017	A01-A	32102-J-0	Carbon tetrachloride	Intermediate Treatment, Process Complete	< 0.22	< 0.22	lbg	< 0.005	< 0.005	mg/L	N	BAS	ENF
IL0001392	EMERALD POLYMER ADDITIVES LLC	07130001-ILLINOIS RIVER	03/31/2019	A01-A	32730-J-0	Phenolics, total recoverable	Intermediate Treatment, Process Complete	< 0.06	< 0.06	lbg	< 0.1	< 0.1	mg/L	N	BAS	ENF
IL0001392	EMERALD POLYMER ADDITIVES LLC	07130001-ILLINOIS RIVER	03/31/2018	A01-A	32730-J-0	Phenolics, total recoverable	Intermediate Treatment, Process Complete	< 0.42	< 0.42	lbg	< 0.1	< 0.1	mg/L	N	BAS	ENF
IL0001392	EMERALD POLYMER ADDITIVES LLC	07130001-ILLINOIS RIVER	03/31/2017	A01-A	32730-J-0	Phenolics, total recoverable	Intermediate Treatment, Process Complete	< 0.44	< 0.44	lbg	< 0.1	< 0.1	mg/L	N	BAS	ENF
IL0001392	EMERALD POLYMER ADDITIVES LLC	07130001-ILLINOIS RIVER	03/31/2019	A01-A	34010-J-0	Toluene	Intermediate Treatment, Process Complete	< 0.3	< 0.3	lbg	< 0.05	< 0.05	mg/L	N	BAS	ENF
IL0001392	EMERALD POLYMER ADDITIVES LLC	07130001-ILLINOIS RIVER	03/31/2018	A01-A	34010-J-0	Toluene	Intermediate Treatment, Process Complete	< 0.21	< 0.21	lbg	< 0.05	< 0.05	mg/L	N	BAS	ENF
IL0001392	EMERALD POLYMER ADDITIVES LLC	07130001-ILLINOIS RIVER	03/31/2017	A01-A	34010-J-0	Toluene	Intermediate Treatment, Process Complete	< 0.22	< 0.22	lbg	< 0.05	< 0.05	mg/L	N	BAS	ENF
IL0001392	EMERALD POLYMER ADDITIVES LLC	07130001-ILLINOIS RIVER	03/31/2019	A01-A	34030-J-0	Benzene	Intermediate Treatment, Process Complete	< 0.3	< 0.3	lbg	< 0.05	< 0.05	mg/L	N	BAS	ENF
IL0001392	EMERALD POLYMER ADDITIVES LLC	07130001-ILLINOIS RIVER	03/31/2018	A01-A	34030-J-0	Benzene	Intermediate Treatment, Process Complete	< 0.21	< 0.21	lbg	< 0.05	< 0.05	mg/L	N	BAS	ENF
IL0001392	EMERALD POLYMER ADDITIVES LLC	07130001-ILLINOIS RIVER	03/31/2017	A01-A	34030-J-0	Benzene	Intermediate Treatment, Process Complete	0.22	0.22	lbg	< 0.05	< 0.05	mg/L	N	BAS	ENF
IL0001392	EMERALD POLYMER ADDITIVES LLC	07130001-ILLINOIS RIVER	03/31/2019	A01-A	34700-J-0	Acenaphthylene	Intermediate Treatment, Process Complete	< 0.06	< 0.06	lbg	< 0.1	< 0.1	mg/L	N	BAS	ENF
IL0001392	EMERALD POLYMER ADDITIVES LLC	07130001-ILLINOIS RIVER	03/31/2018	A01-A	34700-J-0	Acenaphthylene	Intermediate Treatment, Process Complete	< 0.42	< 0.42	lbg	< 0.1	< 0.1	mg/L	N	BAS	ENF
IL0001392	EMERALD POLYMER ADDITIVES LLC	07130001-ILLINOIS RIVER	03/31/2017	A01-A	34700-J-0	Acenaphthylene	Intermediate Treatment, Process Complete	< 0.44	< 0.44	lbg	< 0.1	< 0.1	mg/L	N	BAS	ENF
IL0001392	EMERALD POLYMER ADDITIVES LLC	07130001-ILLINOIS RIVER	03/31/2019	A01-A	34705-J-0	Acenaphthene	Intermediate Treatment, Process Complete	< 0.06	< 0.06	lbg	< 0.1	< 0.1	mg/L	N	BAS	ENF
IL0001392	EMERALD POLYMER ADDITIVES LLC	07130001-ILLINOIS RIVER	03/31/2018	A01-A	34705-J-0	Acenaphthene	Intermediate Treatment, Process Complete	< 0.12	< 0.12	lbg	< 0.1	< 0.1	mg/L	N	BAS	ENF
IL0001392	EMERALD POLYMER ADDITIVES LLC	07130001-ILLINOIS RIVER	03/31/2017	A01-A	34705-J-0	Acenaphthene	Intermediate Treatment, Process Complete	< 0.44	< 0.44	lbg	< 0.1	< 0.1	mg/L	N	BAS	ENF
IL0001392	EMERALD POLYMER ADDITIVES LLC	07130001-ILLINOIS RIVER	03/31/2019	A01-A	34715-J-0	Acrylonitrile	Intermediate Treatment, Process Complete	< 2.08	< 2.08	lbg	< 0.5	< 0.5	mg/L	N	BAS	ENF
IL0001392	EMERALD POLYMER ADDITIVES LLC	07130001-ILLINOIS RIVER	03/31/2018	A01-A	34715-J-0	Acrylonitrile	Intermediate Treatment, Process Complete	< 2.11	< 2.11	lbg	< 0.5	< 0.5	mg/L	N	BAS	ENF
IL0001392	EMERALD POLYMER ADDITIVES LLC	07130001-ILLINOIS RIVER	03/31/2017	A01-A	34715-J-0	Acrylonitrile	Intermediate Treatment, Process Complete	< 2.18	< 2.18	lbg	< 0.5	< 0.5	mg/L	N	BAS	ENF

0.0001322	EMERALD POLYMER ADDITIVES LLC	07130001-ILLINOIS RIVER	03/31/2018	A01-A	34321-J-0	Ethylbenzene	Intermediate Treatment, Process Complete	< 021	< 021	04F	< 005	< 005	mg/L	N	BAS	ENF
0.0001352	EMERALD POLYMER ADDITIVES LLC	07130001-ILLINOIS RIVER	03/31/2017	A01-A	34321-J-0	Ethylbenzene	Intermediate Treatment, Process Complete	< 022	< 022	04F	< 005	< 005	mg/L	N	BAS	ENF
0.0001352	EMERALD POLYMER ADDITIVES LLC	07130001-ILLINOIS RIVER	03/31/2019	A01-A	34326-J-0	Fluoranthene	Intermediate Treatment, Process Complete	< 06	< 06	04F	< 01	< 01	mg/L	N	BAS	ENF
0.0001309	EMERALD POLYMER ADDITIVES LLC	07130001-ILLINOIS RIVER	03/31/2018	A01-A	34316-J-0	Fluoranthene	Intermediate Treatment, Process Complete	< 042	< 042	04F	< 01	< 01	mg/L	N	BAS	ENF
0.0001352	EMERALD POLYMER ADDITIVES LLC	07130001-ILLINOIS RIVER	03/31/2017	A01-A	34326-J-0	Fluoranthene	Intermediate Treatment, Process Complete	< 044	< 044	04F	< 01	< 01	mg/L	N	BAS	ENF
0.0001362	EMERALD POLYMER ADDITIVES LLC	07130001-ILLINOIS RIVER	03/31/2019	A01-A	34381-J-0	Fluorene	Intermediate Treatment, Process Complete	< 06	< 06	04F	< 01	< 01	mg/L	N	BAS	ENF
0.0001362	EMERALD POLYMER ADDITIVES LLC	07130001-ILLINOIS RIVER	03/31/2018	A01-A	34381-J-0	Fluorene	Intermediate Treatment, Process Complete	< 042	< 042	04F	< 01	< 01	mg/L	N	BAS	ENF
0.0001309	EMERALD POLYMER ADDITIVES LLC	07130001-ILLINOIS RIVER	03/31/2017	A01-A	34381-J-0	Fluorene	Intermediate Treatment, Process Complete	< 044	044	04F	< 01	< 01	mg/L	N	BAS	ENF
0.0001352	EMERALD POLYMER ADDITIVES LLC	07130001-ILLINOIS RIVER	03/31/2019	A01-A	34390-J-0	Hexachlorobenzene	Intermediate Treatment, Process Complete	< 06	< 06	04F	< 01	< 01	mg/L	N	BAS	ENF
0.0001309	EMERALD POLYMER ADDITIVES LLC	07130001-ILLINOIS RIVER	03/31/2018	A01-A	34390-J-0	Hexachlorobenzene	Intermediate Treatment, Process Complete	< 042	< 042	04F	< 01	< 01	mg/L	N	BAS	ENF
0.0001392	EMERALD POLYMER ADDITIVES LLC	07130001-ILLINOIS RIVER	03/31/2017	A01-A	34390-J-0	Hexachlorobenzene	Intermediate Treatment, Process Complete	< 044	< 044	04F	< 01	< 01	mg/L	N	BAS	ENF
0.0001302	EMERALD POLYMER ADDITIVES LLC	07130001-ILLINOIS RIVER	03/31/2019	A01-A	34410-J-0	Methyl chloride [Dichloromethane]	Intermediate Treatment, Process Complete	< 02	< 03	04F	< 005	< 005	mg/L	N	BAS	ENF
0.0001302	EMERALD POLYMER ADDITIVES LLC	07130001-ILLINOIS RIVER	03/31/2018	A01-A	34418-J-0	Methyl chloride [Dichloromethane]	Intermediate Treatment, Process Complete	< 021	< 021	04F	< 005	< 005	mg/L	N	BAS	ENF
0.0001302	EMERALD POLYMER ADDITIVES LLC	07130001-ILLINOIS RIVER	03/31/2017	A01-A	34418-J-0	Methyl chloride [Dichloromethane]	Intermediate Treatment, Process Complete	038	038	04F	0088	0088	mg/L	N	BAS	ENF
0.0001392	EMERALD POLYMER ADDITIVES LLC	07130001-ILLINOIS RIVER	03/31/2019	A01-A	34447-J-0	Nitrobenzene	Intermediate Treatment, Process Complete	< 06	< 06	04F	< 01	< 01	mg/L	N	BAS	ENF
0.0001392	EMERALD POLYMER ADDITIVES LLC	07130001-ILLINOIS RIVER	03/31/2018	A01-A	34447-J-0	Nitrobenzene	Intermediate Treatment, Process Complete	< 042	< 042	04F	< 01	< 01	mg/L	N	BAS	ENF
0.0001392	EMERALD POLYMER ADDITIVES LLC	07130001-ILLINOIS RIVER	03/31/2017	A01-A	34447-J-0	Nitrobenzene	Intermediate Treatment, Process Complete	< 044	< 044	04F	< 01	< 01	mg/L	N	BAS	ENF
0.0001302	EMERALD POLYMER ADDITIVES LLC	07130001-ILLINOIS RIVER	03/31/2019	A01-A	34461-J-0	Phenanthrene	Intermediate Treatment, Process Complete	< 06	< 06	04F	< 01	< 01	mg/L	N	BAS	ENF
0.0001392	EMERALD POLYMER ADDITIVES LLC	07130001-ILLINOIS RIVER	03/31/2018	A01-A	34461-J-0	Phenanthrene	Intermediate Treatment, Process Complete	< 042	< 042	04F	< 01	< 01	mg/L	N	BAS	ENF
0.0001302	EMERALD POLYMER ADDITIVES LLC	07130001-ILLINOIS RIVER	03/31/2017	A01-A	34461-J-0	Phenanthrene	Intermediate Treatment, Process Complete	< 044	< 044	04F	< 01	< 01	mg/L	N	BAS	ENF
0.0001302	EMERALD POLYMER ADDITIVES LLC	07130001-ILLINOIS RIVER	03/31/2019	A01-A	34469-J-0	Pyrene	Intermediate Treatment, Process Complete	< 06	< 06	04F	< 01	< 01	mg/L	N	BAS	ENF
0.0001302	EMERALD POLYMER ADDITIVES LLC	07130001-ILLINOIS RIVER	03/31/2018	A01-A	34469-J-0	Pyrene	Intermediate Treatment, Process Complete	< 042	< 042	04F	< 01	< 01	mg/L	N	BAS	ENF

Case No.	Company Name	Address	City	State	Zip	Product	Chemical Name	Concentration	Volume	Start Date	End Date	Analysis Type	Results	Compliance	Notes
1000192	EMERALD POLYMER ADDITIVES LLC	07130091-ILLINOIS RIVER	34541-J0	IL	62412	1,2-Dichloroethane	1,2-Dichloroethane	0.03	1000	03/12/2017	03/12/2017	mp/L	< 0.05	ENF	
1000193	EMERALD POLYMER ADDITIVES LLC	07130091-ILLINOIS RIVER	34541-J0	IL	62412	1,2-Dichloroethane	1,2-Dichloroethane	0.05	1000	03/12/2017	03/12/2017	mp/L	< 0.05	ENF	
1000194	EMERALD POLYMER ADDITIVES LLC	07130091-ILLINOIS RIVER	34541-J0	IL	62412	1,2-Dichloroethane	1,2-Dichloroethane	0.05	1000	03/12/2017	03/12/2017	mp/L	< 0.05	ENF	
1000195	EMERALD POLYMER ADDITIVES LLC	07130091-ILLINOIS RIVER	34546-J0	IL	62412	trans-1,2-Dichloroethane	trans-1,2-Dichloroethane	0.02	1000	03/12/2017	03/12/2017	mp/L	< 0.02	ENF	
1000196	EMERALD POLYMER ADDITIVES LLC	07130091-ILLINOIS RIVER	34546-J0	IL	62412	trans-1,2-Dichloroethane	trans-1,2-Dichloroethane	0.04	1000	03/12/2017	03/12/2017	mp/L	< 0.02	ENF	
1000197	EMERALD POLYMER ADDITIVES LLC	07130091-ILLINOIS RIVER	34546-J0	IL	62412	trans-1,2-Dichloroethane	trans-1,2-Dichloroethane	0.07	1000	03/12/2017	03/12/2017	mp/L	< 0.02	ENF	
1000198	EMERALD POLYMER ADDITIVES LLC	07130091-ILLINOIS RIVER	34541-J0	IL	62412	1,2,4-Trichloroethane	1,2,4-Trichloroethane	0.06	1000	03/12/2017	03/12/2017	mp/L	< 0.01	ENF	
1000199	EMERALD POLYMER ADDITIVES LLC	07130091-ILLINOIS RIVER	34541-J0	IL	62412	1,2,4-Trichloroethane	1,2,4-Trichloroethane	0.02	1000	03/12/2017	03/12/2017	mp/L	< 0.01	ENF	
1000200	EMERALD POLYMER ADDITIVES LLC	07130091-ILLINOIS RIVER	34541-J0	IL	62412	1,2,4-Trichloroethane	1,2,4-Trichloroethane	0.04	1000	03/12/2017	03/12/2017	mp/L	< 0.01	ENF	
1000201	EMERALD POLYMER ADDITIVES LLC	07130091-ILLINOIS RIVER	34546-J0	IL	62412	1,2,4-Trichloroethane	1,2,4-Trichloroethane	0.01	1000	03/12/2017	03/12/2017	mp/L	< 0.01	ENF	
1000202	EMERALD POLYMER ADDITIVES LLC	07130091-ILLINOIS RIVER	34541-J0	IL	62412	1,3-Dichlorobenzene	1,3-Dichlorobenzene	0.06	1000	03/12/2017	03/12/2017	mp/L	< 0.01	ENF	
1000203	EMERALD POLYMER ADDITIVES LLC	07130091-ILLINOIS RIVER	34541-J0	IL	62412	1,3-Dichlorobenzene	1,3-Dichlorobenzene	0.02	1000	03/12/2017	03/12/2017	mp/L	< 0.01	ENF	
1000204	EMERALD POLYMER ADDITIVES LLC	07130091-ILLINOIS RIVER	34546-J0	IL	62412	1,3-Dichlorobenzene	1,3-Dichlorobenzene	0.04	1000	03/12/2017	03/12/2017	mp/L	< 0.01	ENF	
1000205	EMERALD POLYMER ADDITIVES LLC	07130091-ILLINOIS RIVER	34541-J0	IL	62412	1,3-Dichlorobenzene	1,3-Dichlorobenzene	0.06	1000	03/12/2017	03/12/2017	mp/L	< 0.01	ENF	
1000206	EMERALD POLYMER ADDITIVES LLC	07130091-ILLINOIS RIVER	34541-J0	IL	62412	1,4-Dichlorobenzene	1,4-Dichlorobenzene	0.06	1000	03/12/2017	03/12/2017	mp/L	< 0.01	ENF	
1000207	EMERALD POLYMER ADDITIVES LLC	07130091-ILLINOIS RIVER	34546-J0	IL	62412	2,2-Dichloropropane	2,2-Dichloropropane	0.06	1000	03/12/2017	03/12/2017	mp/L	< 0.01	ENF	
1000208	EMERALD POLYMER ADDITIVES LLC	07130091-ILLINOIS RIVER	34546-J0	IL	62412	2-Chlorophenol	2-Chlorophenol	0.02	1000	03/12/2017	03/12/2017	mp/L	< 0.01	ENF	
1000209	EMERALD POLYMER ADDITIVES LLC	07130091-ILLINOIS RIVER	34546-J0	IL	62412	2-Chlorophenol	2-Chlorophenol	0.04	1000	03/12/2017	03/12/2017	mp/L	< 0.01	ENF	
1000210	EMERALD POLYMER ADDITIVES LLC	07130091-ILLINOIS RIVER	34541-J0	IL	62412	2-Naphthol	2-Naphthol	0.06	1000	03/12/2017	03/12/2017	mp/L	< 0.01	ENF	
1000211	EMERALD POLYMER ADDITIVES LLC	07130091-ILLINOIS RIVER	34541-J0	IL	62412	2-Naphthol	2-Naphthol	0.04	1000	03/12/2017	03/12/2017	mp/L	< 0.01	ENF	
1000212	EMERALD POLYMER ADDITIVES LLC	07130091-ILLINOIS RIVER	34601-J0	IL	62412	2,4-Dichlorophenol	2,4-Dichlorophenol	0.06	1000	03/12/2017	03/12/2017	mp/L	< 0.01	ENF	

IL0001392	EMERALD POLYMER ADDITIVES LLC	07130001-ILLINOIS RIVER	03/31/2019	A01-A	70531-J-0	3,4-Benzofluoranthene	Intermediate Treatment, Process Complete	< .06	< .06	lb/d		< .01	< .01	mg/L	N		BAS	ENF
IL0001392	EMERALD POLYMER ADDITIVES LLC	07130001-ILLINOIS RIVER	03/31/2018	A01-A	70531-J-0	3,4-Benzofluoranthene	Intermediate Treatment, Process Complete	< .042	< .042	lb/d		< .01	< .01	mg/L	N		BAS	ENF
IL0001392	EMERALD POLYMER ADDITIVES LLC	07130001-ILLINOIS RIVER	03/31/2017	A01-A	70531-J-0	3,4-Benzofluoranthene	Intermediate Treatment, Process Complete	.044	.044	lb/d		< .01	.01	mg/L	N		BAS	ENF
IL0001392	EMERALD POLYMER ADDITIVES LLC	07130001-ILLINOIS RIVER	03/31/2019	A01-A	85811-J-0	Chloroethane	Intermediate Treatment, Process Complete	< .03	< .03	lb/d		< .005	< .005	mg/L	N		BAS	ENF
IL0001392	EMERALD POLYMER ADDITIVES LLC	07130001-ILLINOIS RIVER	03/31/2018	A01-A	85811-J-0	Chloroethane	Intermediate Treatment, Process Complete	< .021	< .021	lb/d		< .005	< .005	mg/L	N		BAS	ENF
IL0001392	EMERALD POLYMER ADDITIVES LLC	07130001-ILLINOIS RIVER	03/31/2017	A01-A	85811-J-0	Chloroethane	Intermediate Treatment, Process Complete	.022	.022	lb/d		.006	.006	mg/L	N		BAS	ENF
IL0001392	EMERALD POLYMER ADDITIVES LLC	07130001-ILLINOIS RIVER	03/31/2019	A01-A	85814-J-0	Tetrachloroethylene	Intermediate Treatment, Process Complete	< .03	< .03	lb/d		< .005	< .005	mg/L	N		BAS	ENF
IL0001392	EMERALD POLYMER ADDITIVES LLC	07130001-ILLINOIS RIVER	03/31/2018	A01-A	85814-J-0	Tetrachloroethylene	Intermediate Treatment, Process Complete	< .021	< .021	lb/d		< .005	< .005	mg/L	N		BAS	ENF
IL0001392	EMERALD POLYMER ADDITIVES LLC	07130001-ILLINOIS RIVER	03/31/2017	A01-A	85814-J-0	Tetrachloroethylene	Intermediate Treatment, Process Complete	< .022	< .022	lb/d		< .005	< .005	mg/L	N		BAS	ENF
IL0001392	EMERALD POLYMER ADDITIVES LLC	07130001-ILLINOIS RIVER	09/30/2019	A01-Q	32106-J-0	Chloroform	Intermediate Treatment, Process Complete	.093	.115	lb/d		.019	.033	mg/L	N		BAS	ENF
IL0001392	EMERALD POLYMER ADDITIVES LLC	07130001-ILLINOIS RIVER	06/30/2019	A01-Q	32106-J-0	Chloroform	Intermediate Treatment, Process Complete	.043	.043	lb/d		.0075	.0075	mg/L	N		BAS	ENF
IL0001392	EMERALD POLYMER ADDITIVES LLC	07130001-ILLINOIS RIVER	03/31/2016	A01-Q	32106-J-0	Chloroform	Intermediate Treatment, Process Complete	< .004	< .004	lb/d		< .0008	< .0008	mg/L	N		BAS	ENF
IL0001392	EMERALD POLYMER ADDITIVES LLC	07130001-ILLINOIS RIVER	12/31/2018	A01-Q	32106-J-0	Chloroform	Intermediate Treatment, Process Complete	.015	.015	lb/d		.0031	.0031	mg/L	N		BAS	ENF
IL0001392	EMERALD POLYMER ADDITIVES LLC	07130001-ILLINOIS RIVER	09/30/2018	A01-Q	32106-J-0	Chloroform	Intermediate Treatment, Process Complete	< .004	< .004	lb/d		< .0008	< .0008	mg/L	N		BAS	ENF
IL0001392	EMERALD POLYMER ADDITIVES LLC	07130001-ILLINOIS RIVER	06/30/2018	A01-Q	32106-J-0	Chloroform	Intermediate Treatment, Process Complete	< .005	< .005	lb/d		< .001	< .001	mg/L	N		BAS	ENF
IL0001392	EMERALD POLYMER ADDITIVES LLC	07130001-ILLINOIS RIVER	03/31/2018	A01-Q	32106-J-0	Chloroform	Intermediate Treatment, Process Complete	.016	.028	lb/d		.0038	.0066	mg/L	N		BAS	ENF
IL0001392	EMERALD POLYMER ADDITIVES LLC	07130001-ILLINOIS RIVER	12/31/2017	A01-Q	32106-J-0	Chloroform	Intermediate Treatment, Process Complete	< .004	< .004	lb/d		< .001	< .001	mg/L	N		BAS	ENF
IL0001392	EMERALD POLYMER ADDITIVES LLC	07130001-ILLINOIS RIVER	09/30/2017	A01-Q	32106-J-0	Chloroform	Intermediate Treatment, Process Complete	.029	.029	lb/d		.0073	.0073	mg/L	N		BAS	ENF
IL0001392	EMERALD POLYMER ADDITIVES LLC	07130001-ILLINOIS RIVER	08/30/2017	A01-Q	32106-J-0	Chloroform	Intermediate Treatment, Process Complete	< .004	< .004	lb/d		< .001	< .001	mg/L	N		BAS	ENF
IL0001392	EMERALD POLYMER ADDITIVES LLC	07130001-ILLINOIS RIVER	03/31/2017	A01-Q	32106-J-0	Chloroform	Intermediate Treatment, Process Complete	.004	.004	lb/d		.001	.001	mg/L	N		BAS	ENF
IL0001392	EMERALD POLYMER ADDITIVES LLC	07130001-ILLINOIS RIVER	12/31/2016	A01-Q	32106-J-0	Chloroform	Intermediate Treatment, Process Complete	.009	.009	lb/d		.0025	.0025	mg/L	N		BAS	ENF
IL0001392	EMERALD POLYMER ADDITIVES LLC	07130001-ILLINOIS RIVER	09/30/2016	A01-Q	32106-J-0	Chloroform	Intermediate Treatment, Process Complete	.011	.011	lb/d		.003	.003	mg/L	N		BAS	ENF

IL0001392	EMERALD POLYMER ADDITIVES LLC	07130001-ILLINOIS RIVER	06/09/2019	A01-Q	32106-J-0	Chloroform	Intermediate Treatment, Process Complete	011	011	02E	005	003	ng/L	N	BAS	ENF
IL0001393	EMERALD POLYMER ADDITIVES LLC	07130001-ILLINOIS RIVER	11/02/2019	B01-D	00310-J-0	BOD, 5-day, 20 deg C	Intermediate Treatment, Process Complete					NODIC	ng/L	N	BAS	ENF
IL0001394	EMERALD POLYMER ADDITIVES LLC	07130001-ILLINOIS RIVER	10/12/2019	B01-D	00310-J-0	BOD, 5-day, 20 deg C	Intermediate Treatment, Process Complete					NODIC	ng/L	N	BAS	ENF
IL0001395	EMERALD POLYMER ADDITIVES LLC	07130001-ILLINOIS RIVER	09/30/2019	B01-D	00310-J-0	BOD, 5-day, 20 deg C	Intermediate Treatment, Process Complete				5.7		ng/L	N	BAS	ENF
IL0001396	EMERALD POLYMER ADDITIVES LLC	07130001-ILLINOIS RIVER	06/21/2019	B01-D	00310-J-0	BOD, 5-day, 20 deg C	Intermediate Treatment, Process Complete					NODIC	ng/L	N	BAS	ENF
IL0001397	EMERALD POLYMER ADDITIVES LLC	07130001-ILLINOIS RIVER	07/01/2019	B01-D	00310-J-0	BOD, 5-day, 20 deg C	Intermediate Treatment, Process Complete					NODIC	ng/L	N	BAS	ENF
IL0001398	EMERALD POLYMER ADDITIVES LLC	07130001-ILLINOIS RIVER	06/20/2019	B01-D	00310-J-0	BOD, 5-day, 20 deg C	Intermediate Treatment, Process Complete				21		ng/L	N	BAS	ENF
IL0001399	EMERALD POLYMER ADDITIVES LLC	07130001-ILLINOIS RIVER	05/21/2019	B01-D	00310-J-0	BOD, 5-day, 20 deg C	Intermediate Treatment, Process Complete					NODIC	ng/L	N	BAS	ENF
IL0001400	EMERALD POLYMER ADDITIVES LLC	07130001-ILLINOIS RIVER	04/20/2019	B01-D	00310-J-0	BOD, 5-day, 20 deg C	Intermediate Treatment, Process Complete					NODIC	ng/L	N	BAS	ENF
IL0001401	EMERALD POLYMER ADDITIVES LLC	07130001-ILLINOIS RIVER	03/31/2019	B01-D	00310-J-0	BOD, 5-day, 20 deg C	Intermediate Treatment, Process Complete					NODIC	ng/L	N	BAS	ENF
IL0001402	EMERALD POLYMER ADDITIVES LLC	07130001-ILLINOIS RIVER	07/28/2019	B01-D	00310-J-0	BOD, 5-day, 20 deg C	Intermediate Treatment, Process Complete					NODIC	ng/L	N	BAS	ENF
IL0001403	EMERALD POLYMER ADDITIVES LLC	07130001-ILLINOIS RIVER	01/12/2019	B01-D	00310-J-0	BOD, 5-day, 20 deg C	Intermediate Treatment, Process Complete					NODIC	ng/L	N	BAS	ENF
IL0001404	EMERALD POLYMER ADDITIVES LLC	07130001-ILLINOIS RIVER	12/01/2018	B01-D	00310-J-0	BOD, 5-day, 20 deg C	Intermediate Treatment, Process Complete					NODIC	ng/L	N	BAS	ENF
IL0001405	EMERALD POLYMER ADDITIVES LLC	07130001-ILLINOIS RIVER	11/20/2018	B01-D	00310-J-0	BOD, 5-day, 20 deg C	Intermediate Treatment, Process Complete					NODIC	ng/L	N	BAS	ENF
IL0001406	EMERALD POLYMER ADDITIVES LLC	07130001-ILLINOIS RIVER	10/31/2018	B01-D	00310-J-0	BOD, 5-day, 20 deg C	Intermediate Treatment, Process Complete					NODIC	ng/L	N	BAS	ENF
IL0001407	EMERALD POLYMER ADDITIVES LLC	07130001-ILLINOIS RIVER	09/30/2018	B01-D	00310-J-0	BOD, 5-day, 20 deg C	Intermediate Treatment, Process Complete					NODIC	ng/L	N	BAS	ENF
IL0001408	EMERALD POLYMER ADDITIVES LLC	07130001-ILLINOIS RIVER	08/31/2018	B01-D	00310-J-0	BOD, 5-day, 20 deg C	Intermediate Treatment, Process Complete					NODIC	ng/L	N	BAS	ENF
IL0001409	EMERALD POLYMER ADDITIVES LLC	07130001-ILLINOIS RIVER	07/31/2018	B01-D	00310-J-0	BOD, 5-day, 20 deg C	Intermediate Treatment, Process Complete					NODIC	ng/L	N	BAS	ENF
IL0001410	EMERALD POLYMER ADDITIVES LLC	07130001-ILLINOIS RIVER	06/30/2018	B01-D	00310-J-0	BOD, 5-day, 20 deg C	Intermediate Treatment, Process Complete					NODIC	ng/L	N	BAS	ENF
IL0001411	EMERALD POLYMER ADDITIVES LLC	07130001-ILLINOIS RIVER	05/31/2018	B01-D	00310-J-0	BOD, 5-day, 20 deg C	Intermediate Treatment, Process Complete					NODIC	ng/L	N	BAS	ENF
IL0001412	EMERALD POLYMER ADDITIVES LLC	07130001-ILLINOIS RIVER	04/30/2018	B01-D	00310-J-0	BOD, 5-day, 20 deg C	Intermediate Treatment, Process Complete					NODIC	ng/L	N	BAS	ENF
IL0001413	EMERALD POLYMER ADDITIVES LLC	07130001-ILLINOIS RIVER	03/31/2018	B01-D	00310-J-0	BOD, 5-day, 20 deg C	Intermediate Treatment, Process Complete					NODIC	ng/L	N	BAS	ENF

Item	Company	Address	City	State	Zip	Permit	Category	Regulation	Standard	Method	Frequency	Result	Notes
L0001300	EMERALD POLYMER ADDITIVES LLC	071300014LLNDIS	ILLINOIS	042002016	RIVER	B01-0	00530-J0	Subs. limit	mg/L	NODIC	ENF	ENF	Complete Treatment Process
L0001300	EMERALD POLYMER ADDITIVES LLC	071300014LLNDIS	ILLINOIS	110302019	RIVER	B01-0	01045-J0	Iron total	mg/L	NODIC	ENF	ENF	Complete Interim/Initial Treatment Process
L0001300	EMERALD POLYMER ADDITIVES LLC	071300014LLNDIS	ILLINOIS	100312019	RIVER	B01-0	01045-J0	Iron total	mg/L	NODIC	ENF	ENF	Complete Interim/Initial Treatment Process
L0001300	EMERALD POLYMER ADDITIVES LLC	071300014LLNDIS	ILLINOIS	090302019	RIVER	B01-0	01045-J0	Iron total	mg/L	GH	BAS	ENF	Complete Interim/Initial Treatment Process
L0001300	EMERALD POLYMER ADDITIVES LLC	071300014LLNDIS	ILLINOIS	060310210	RIVER	B01-0	01045-J0	Iron total	mg/L	NODIC	BAS	ENF	Complete Interim/Initial Treatment Process
L0001300	EMERALD POLYMER ADDITIVES LLC	071300014LLNDIS	ILLINOIS	070312019	RIVER	B01-0	01045-J0	Iron total	mg/L	NODIC	BAS	ENF	Complete Interim/Initial Treatment Process
L0001300	EMERALD POLYMER ADDITIVES LLC	071300014LLNDIS	ILLINOIS	060302019	RIVER	B01-0	01045-J0	Iron total	mg/L	TF	BAS	ENF	Complete Interim/Initial Treatment Process
L0001300	EMERALD POLYMER ADDITIVES LLC	071300014LLNDIS	ILLINOIS	050312019	RIVER	B01-0	01045-J0	Iron total	mg/L	NODIC	BAS	ENF	Complete Interim/Initial Treatment Process
L0001300	EMERALD POLYMER ADDITIVES LLC	071300014LLNDIS	ILLINOIS	040302019	RIVER	B01-0	01045-J0	Iron total	mg/L	NODIC	BAS	ENF	Complete Interim/Initial Treatment Process
L0001300	EMERALD POLYMER ADDITIVES LLC	071300014LLNDIS	ILLINOIS	030312019	RIVER	B01-0	01045-J0	Iron total	mg/L	NODIC	BAS	ENF	Complete Interim/Initial Treatment Process
L0001300	EMERALD POLYMER ADDITIVES LLC	071300014LLNDIS	ILLINOIS	020302019	RIVER	B01-0	01045-J0	Iron total	mg/L	NODIC	BAS	ENF	Complete Interim/Initial Treatment Process
L0001300	EMERALD POLYMER ADDITIVES LLC	071300014LLNDIS	ILLINOIS	010312018	RIVER	B01-0	01045-J0	Iron total	mg/L	NODIC	BAS	ENF	Complete Interim/Initial Treatment Process
L0001300	EMERALD POLYMER ADDITIVES LLC	071300014LLNDIS	ILLINOIS	120312018	RIVER	B01-0	01045-J0	Iron total	mg/L	NODIC	BAS	ENF	Complete Interim/Initial Treatment Process
L0001300	EMERALD POLYMER ADDITIVES LLC	071300014LLNDIS	ILLINOIS	110302018	RIVER	B01-0	01045-J0	Iron total	mg/L	NODIC	BAS	ENF	Complete Interim/Initial Treatment Process
L0001300	EMERALD POLYMER ADDITIVES LLC	071300014LLNDIS	ILLINOIS	100312018	RIVER	B01-0	01045-J0	Iron total	mg/L	NODIC	BAS	ENF	Complete Interim/Initial Treatment Process
L0001300	EMERALD POLYMER ADDITIVES LLC	071300014LLNDIS	ILLINOIS	090302018	RIVER	B01-0	01045-J0	Iron total	mg/L	NODIC	BAS	ENF	Complete Interim/Initial Treatment Process
L0001300	EMERALD POLYMER ADDITIVES LLC	071300014LLNDIS	ILLINOIS	080312018	RIVER	B01-0	01045-J0	Iron total	mg/L	NODIC	BAS	ENF	Complete Interim/Initial Treatment Process
L0001300	EMERALD POLYMER ADDITIVES LLC	071300014LLNDIS	ILLINOIS	070312018	RIVER	B01-0	01045-J0	Iron total	mg/L	NODIC	BAS	ENF	Complete Interim/Initial Treatment Process
L0001300	EMERALD POLYMER ADDITIVES LLC	071300014LLNDIS	ILLINOIS	060302018	RIVER	B01-0	01045-J0	Iron total	mg/L	NODIC	BAS	ENF	Complete Interim/Initial Treatment Process
L0001300	EMERALD POLYMER ADDITIVES LLC	071300014LLNDIS	ILLINOIS	050312018	RIVER	B01-0	01045-J0	Iron total	mg/L	NODIC	BAS	ENF	Complete Interim/Initial Treatment Process
L0001300	EMERALD POLYMER ADDITIVES LLC	071300014LLNDIS	ILLINOIS	040302018	RIVER	B01-0	01045-J0	Iron total	mg/L	NODIC	BAS	ENF	Complete Interim/Initial Treatment Process
L0001300	EMERALD POLYMER ADDITIVES LLC	071300014LLNDIS	ILLINOIS	030312018	RIVER	B01-0	01045-J0	Iron total	mg/L	NODIC	BAS	ENF	Complete Interim/Initial Treatment Process

00001700 EMERALD POLYMER 07130601 ALLPORS 04/03/2016 B07-6 P01333-0 Chemical oxygen demand Intermediate Treatment Process Complete HODI-C HODI-C mg/L M BAC: ENE

algaewheel®

*An Algae Based Treatment System Provides A Truly Sustainable
Treatment Solution For Small & Seasonal Wastewater Treatment Plants*



ONEwater
Treatment redefined

EXHIBIT
8

Agenda

- ***Small and Seasonal Plant Issues***
- ***Algae and Bacteria in Symbiosis***
- ***Cincinnati Nature Center Case Study***
- ***Indiana Dunes Case Study***
- ***Summit Lake State Park Case Study***

Small/Seasonal Treatment Challenges

The design and operation of a small and seasonal wastewater treatment facility is a tough challenge faced by engineers, owners and operators

- ❑ Owners often install these type of facilities because there is no other choice
- ❑ Tens of thousands of these small-scale facilities service a wide range of applications
- ❑ Many small/decentralized systems;



Treatment Technology Available for Small Plants

Many small/decentralized facilities are in need of urgent upgrade and must now meet tightening permit limits and reduce operating costs

- ❑ Viable options for retrofit have been limited to familiar solutions
- ❑ Algaewheel is a revolutionary technology that looked to nature for inspiration, and the result is technology that uses daylight to power a superior treatment biology.



Algaewheel Biological Process

Algal biofilms provide superior ecology that delivers enhanced fixed film treatment

- ❑ Algaewheel uses photosynthesis to cultivate a diverse ecological environment
- ❑ Strong symbiosis between algae & bacteria makes the system very efficient and resistant to fluctuation

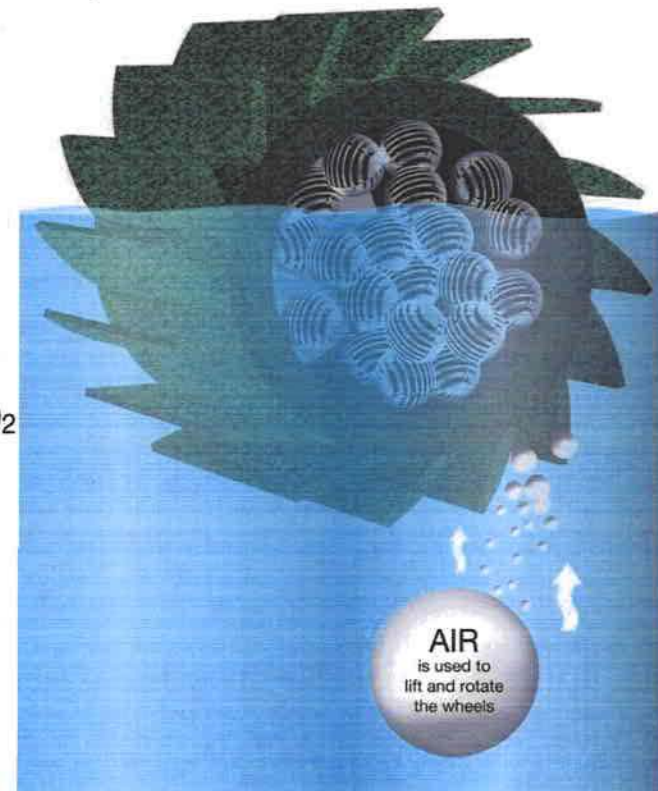
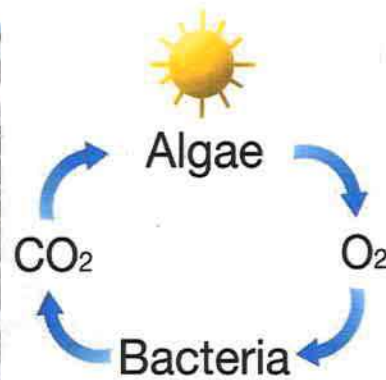

algaewheel®

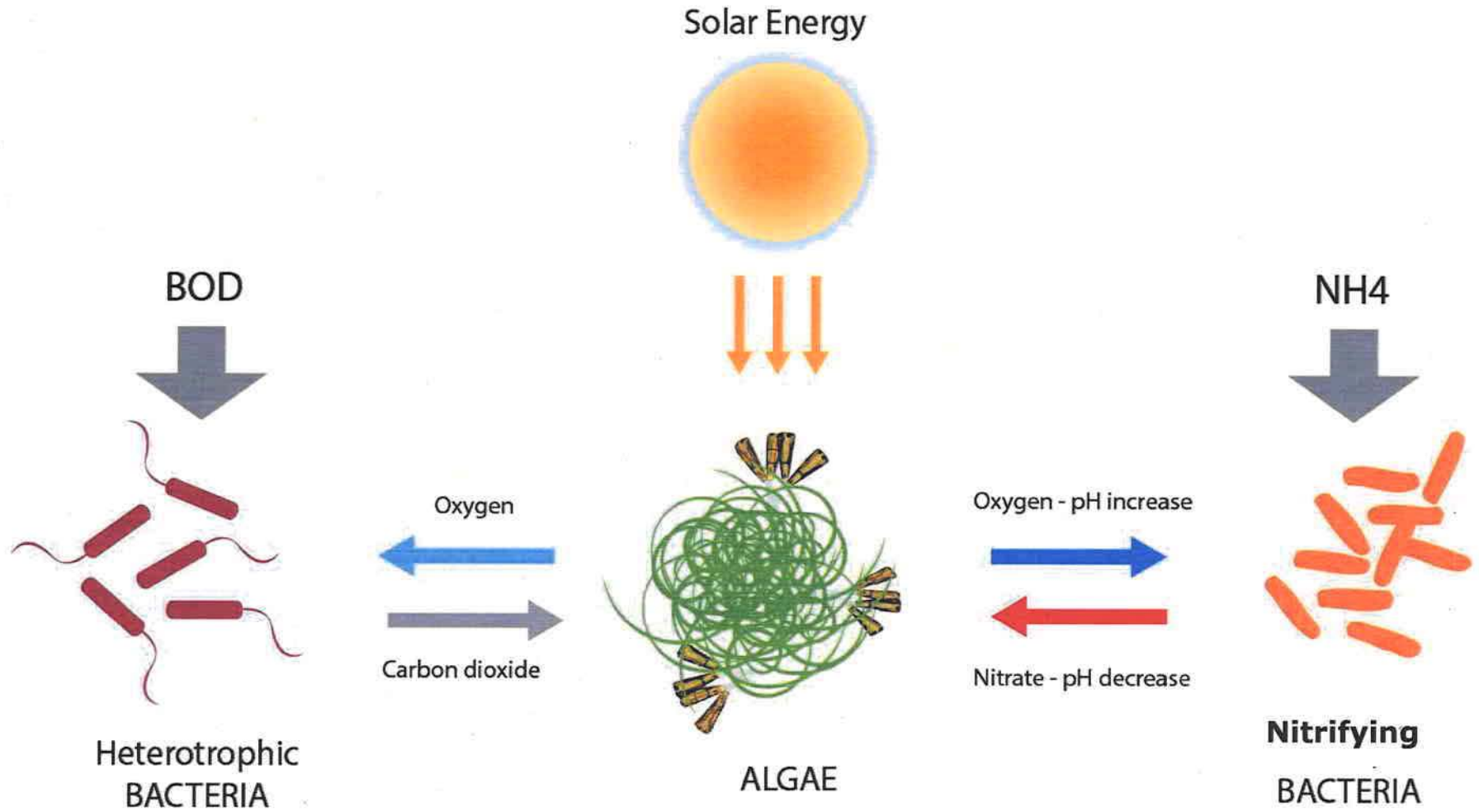

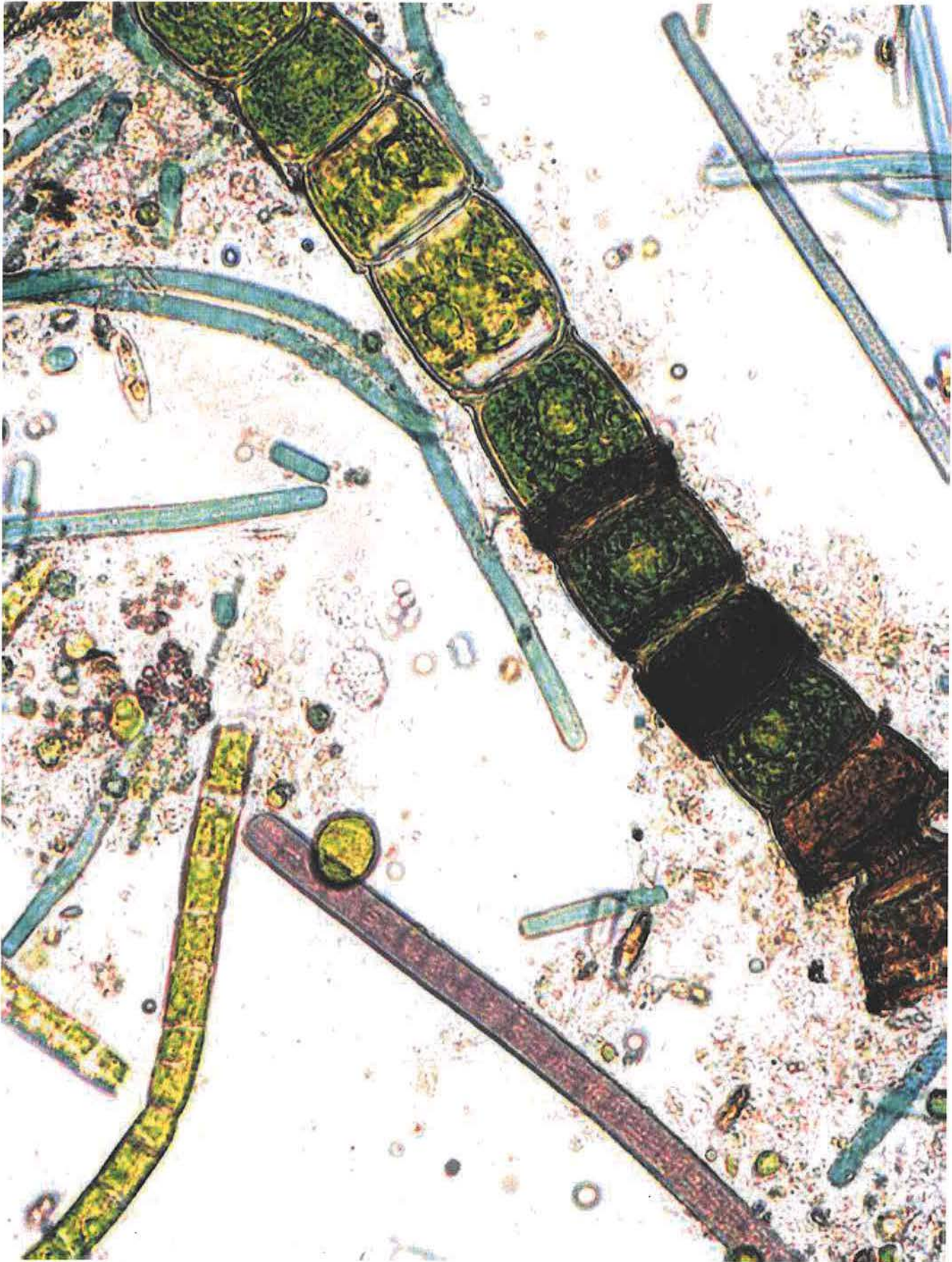

Cincinnati Nature Center is a non-profit Nature Education organization whose Mission is to inspire passion for Nature and promote environmentally responsible choices through involvement, education and conservancy.

- In 2010 the planned expansion of the Center was slowed:**
 - a) two existing forty year old subsurface wastewater treatment plants were noisy, smelled and were expensive to operate**
 - b) connecting the Center to County's sewer system would cost \$ 1million**
 - c) a proposed Constructed Wetland was rejected due to both cost and the large area it would require**

- The Solution - construct an Algaewheel Treatment plant in 2011 to meet EPA's stringent new requirements of BOD – 10 mg/l, SS – 12 mg/l, NH4 – 1 mg/l summer
- 3 mg/l winter**

Cincinnati Nature Center - 2011

One of the largest non-profit, nature education organizations in the country. Open year round, center required environmentally friendly treatment solution

- ❑ The center has a restaurant, bathrooms and shower facilities
 - ❑ waste streams have very high levels of ammonia
- ❑ Plant designed for 20-25 mg/L ammonia
- ❑ Actual ammonia averaged 52.9 with peaks of >120mg/l
- ❑ Flows from 0 to 4 times peaking
- ❑ System has reliably met all NPDES requirements (10/12/1)
 - ❑ now in its 4th year of successful operation
 - ❑ discharges to local stream



Performance Analysis – Cincinnati Nature Center



Ammonia

Effluent Ammonia concentrations were below weekly & monthly permit limits of 4.5 and 3 mg/l during winter and 1.5 mg/l and 1 mg/l during the summer respectively for the study period

Avg. influent 52.9 mg/L (max 120 mg/l)*

Avg. effluent 0.2 mg/L (max 2.3 mg/l)**

* System designed for average ammonia of 25 - 30mg/l

** Peaks were observed on 3 occasions caused by operational related issues



Low Flows

Even through periods of low flow, the system continued to consistently meet permit limits

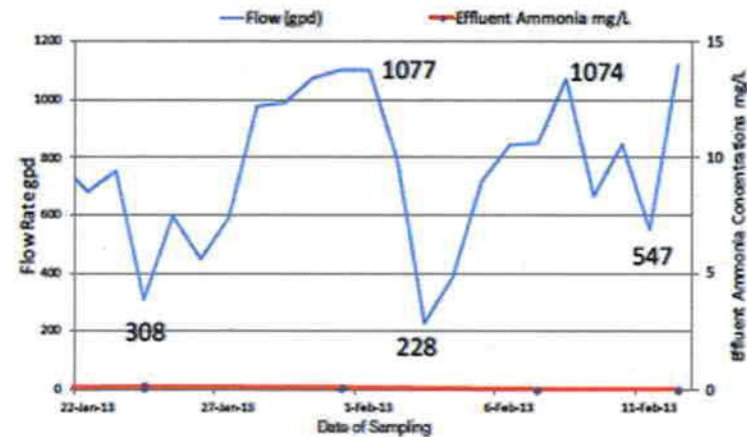

Performance Analysis – Cincinnati Nature Center



The case study summarizes 3 years of data collected up to October 2014 demonstrating the ability of Algaewheel to reliably comply with permit limits

CBOD

Effluent CBOD5 concentrations were below weekly & monthly permit limits of 15 and 10 mg/l respectively for study period

Avg. influent 123 mg/L (max 371 mg/l)

Avg. effluent 2.3 mg/L (max 7 mg/l)

TSS

Effluent TSS concentrations were below weekly & monthly permit limits of 12 and 18 mg/l respectively for study period

Avg. influent 227 mg/L (max 716 mg/l)

Avg. effluent 4.3 mg/L (max 11.6 mg/l)

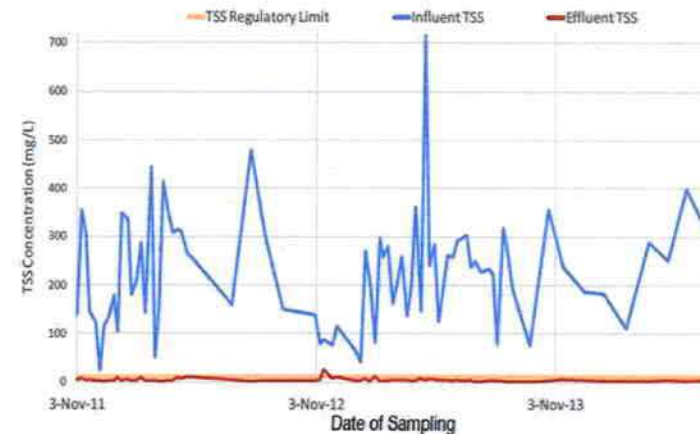
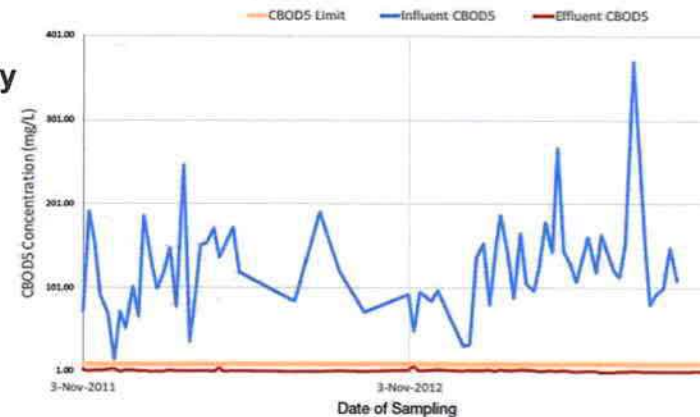

Parameter	Weekly Limit	Monthly Limit
CBOD5	15	10
TSS	18	12
Ammonia: Winter	4.5	3
Ammonia: Summer	1.5	1
Total Phosphorous	N/A	N/A
Total Nitrogen	N/A	N/A

Table 1. NPDES permit limits for Cincinnati Nature Center

Indiana Dunes State Park (DNR) - 2010



- Indiana Dunes State Park's aging steel package plant needed to be replaced.
- Indiana Department of Natural Resources hired Commonwealth Engineers to design a
 - new concrete activated sludge plant with discharge to an adsorption field.
- The DNR and the engineer accepted the successful contractor's alternate to install an
 - Algaewheel Treatment system due to simplicity of operation and operational cost savings.
- In 2011 – The Indiana Dunes State Park installed an Algaewheel Treatment system

Indiana Dunes State Park (DNR) - 2011



One of the top 5 environmentally sensitive and protected state parks in the U.S. due to its unique characteristics on the shore of Lake Michigan



- The park has an R.V. park, camping and extensive bathroom and shower facilities
- Plant designed for 34,000 gpd
- July 2014 flow averaged 79,600 gpd with peaks 95,000 gpd
- System has reliably met all regulatory requirements
 - now in its 4th year of successful operation
 - BOD 30, TSS 30
 - discharge to subsurface drip irrigation field



Performance Analysis – Indiana Dunes

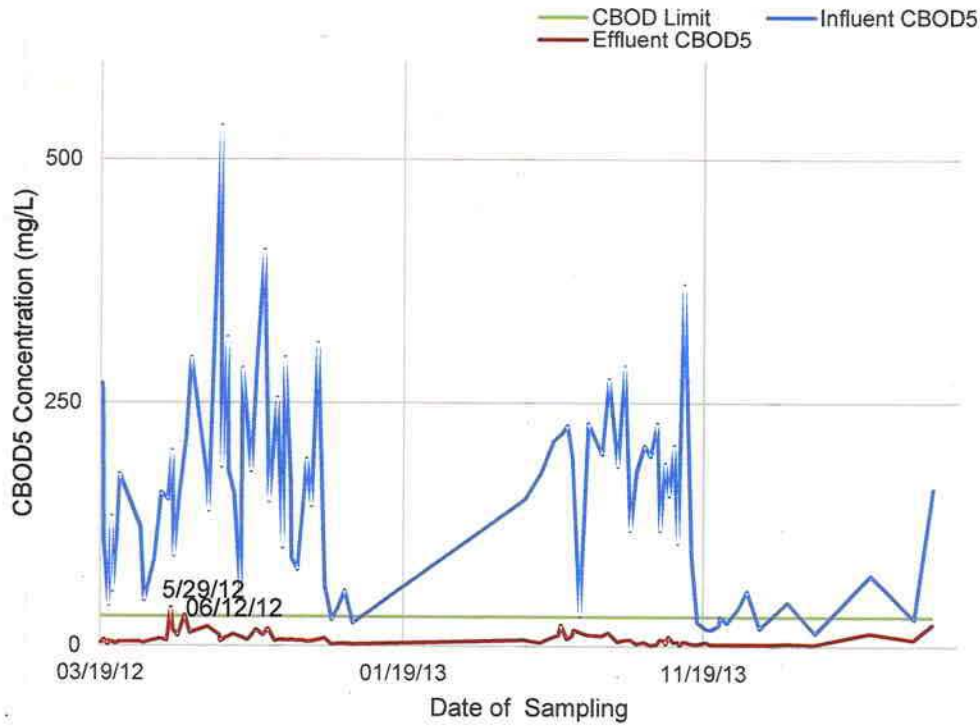

Dunes ATP has consistently met CBOD and TSS limits

Performance Analysis – Indiana Dunes

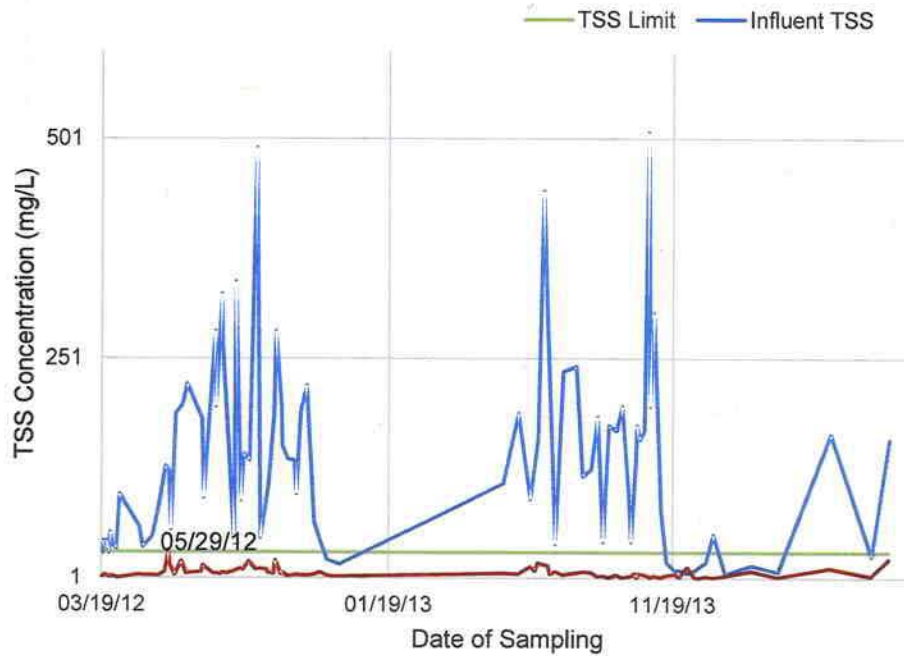

Dunes has consistently met TSS limits.

Summit Lake State Park, Indiana (DNR) - 2014



Based on the Success of the facilities at Cincinnati Nature Center and the Indiana Dunes –

The Indiana DNR has decided to Retrofit of failing plant constructed in 1988 using first modularized ATP

- ❑ The park has a R.V. park, camping, staff housing, extensive bathroom facilities
 - ❑ waste streams have very high levels of ammonia peaking at >120mg/l
- ❑ Plant designed for 12,000 gpd with 60mg/L ammonia
- ❑ Upgrade of plant failing to meet 25/30/12 limits to 10/12/11P

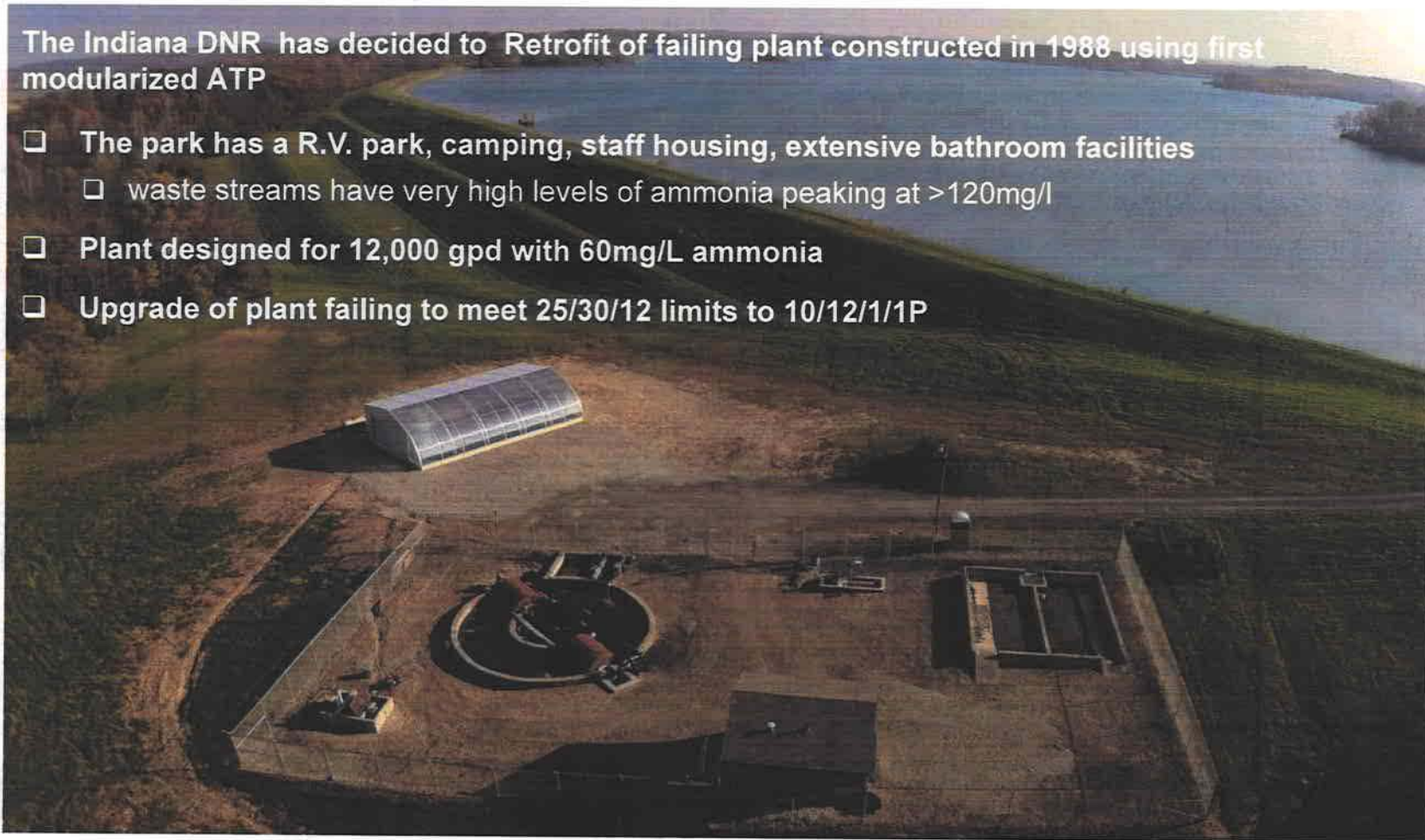

Advanced Treatment Made Simple and Affordable

ONEwater
Treatment redefined



ATP Wheel Basins at Summit Lake



Thank you!

algaewheel®

exclusively from

ONE∞water®
Treatment redefined

From: Houston Flippin <HFlippin@Brwncald.com>
Sent: Thursday, August 1, 2019 6:56 PM
To: Dimond, Thomas <Thomas.Dimond@icemiller.com>
Cc: Jason Mullen <JMullen@Brwncald.com>
Subject: [EXT] RE: Expert Testimony for Emerald Polymer Adjusted Standard

****EXTERNAL EMAIL****

Tom,

Page 21 instructs us that we must prove that the cost of ammonia-nitrogen removal at Henry Plant is inordinately higher than what Board contemplated.

The Board contemplated ammonia-nitrogen removal achievable at POTWs. This is ammonia-nitrogen removal within same but larger tankage, additional blowers, and additional chemical addition.

At Henry Plant significant investment has to be incurred to prepare the wastewater (MBT removal) so the Board contemplated answer can apply. Secondly, all other means of NH3-N removal are much more expensive per unit cost of NH3-N removed than that contemplated by Board.

The Board desperately wants the Henry Plant to reveal operating profit versus cost of partial or full compliance. Can this matter be settled without having to present this?

I am waiting on feedback from our in-house counsel on the letter of engagement. We have had no difficulty with arriving at a mutually satisfactory agreement in prior engagements in such matters. I do not anticipate difficulty here.

We have land application experts on staff that I routinely engage. So, we can address this alternative.

I will forward any proposed revisions to the letter of engagement as soon as I receive them.

Regards,
Houston
T. Houston Flippin, P.E., BCEE
Industrial Wastewater Process Leader
Brown and Caldwell
HFlippin@brwncald.com
T 615.250.1220 | C 615.347.0416



* Professional Registration in Specific States

From: Thomas.Dimond@icemiller.com <Thomas.Dimond@icemiller.com>
Sent: Wednesday, July 31, 2019 11:22 AM
To: Houston Flippin <HFlippin@Brwncald.com>
Subject: Expert Testimony for Emerald Polymer Adjusted Standard

Houston:
See attached draft of engagement letter. If it is acceptable, let me know and I will print and sign it for final execution.

I have also attached Emerald's petition and Illinois EPA's recommendation in response to Emerald's petition to renew the adjusted standard. Both those documents are fairly large, so I hope they get through your firewall. At a minimum, we will need you to address the following:

- On p. 15 of Illinois EPA's recommendation, it faults Emerald for not re-evaluating all the compliance alternatives previously evaluated. We want you to perform such an updated analysis similar to what you did in 2012.
- On pp. 18 and 27 (item g), Illinois EPA has suggested further consideration of a spray irrigation alternative. We may want you to compare the Akzo Nobel spray irrigation system and evaluate that issue for the Henry Plant.

There may be some other issues that we will need you to evaluate. I will contact you to discuss those.

Tom
Thomas W. Dimond
Ice Miller LLP
200 W. Madison Street, Ste. 3500
Chicago, IL 60606-3417
312-726-7125
312-208-7930 (cell)
thomas.dimond@icemiller.com

CONFIDENTIALITY NOTICE: This E-mail and any attachments are confidential and may be protected by legal privilege. If you are not the intended recipient, be aware that any disclosure, copying, distribution, or use of this E-mail or any attachment is prohibited. If you have received this E-mail in error, please notify us immediately by returning it to the sender and delete this copy from your system.
Thank you.
ICE MILLER LLP

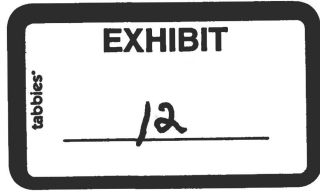

EP002562

220 Athens Way, Suite 500
Nashville, Tennessee 37228

T: 615.255.2288
F: 615.256.8332

August 19, 2019

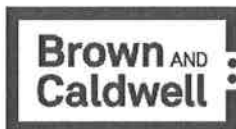

Letter Proposal

Privileged and Confidential

Mr. Galen Hathcock
Plant Manager
Emerald Performance Materials, LLC
1150 County Road 1450 North
Henry, Illinois 61537

041514

Subject: Proposal for Assisting in Adjusted Standard Appeal

Dear Mr. Hathcock:

Brown and Caldwell (BC) is pleased to submit this proposal to assist Tom Diamond of ICE MILLER LLP in the defending of the request for an Adjusted Standard for the Emerald Performance Materials, LLC (Emerald) facility in Henry, Illinois.

Scope of Work

This scope of work will consist of addressing specific tasks requested by ICE Miller, updating conceptual cost estimates for the top five lowest cost alternatives previously presented, and attendance by Mr. Houston Flippin to both the deposition and Marshall County hearing.

Task 1: IEPA Recommendations for an Adjusted Standard

As part of this scope of work, BC will address the following specific tasks requested by ICE Miller to address in the Illinois Environmental Protection Agency (IEPA) Recommendations for an Adjusted Standard (Recommendations) are as follows¹:

1. Explain why the cost comparison described on Page 16 is legitimate. IEPA believes these costs do not represent both capital and operating expenses. Explain why present worth costs true comparison are.
2. Read Emerald's documents on spray irrigation submitted in 2018 and 2019 as well as Akzo Nobel system. Address comment on Page 18 regarding why spray irrigation on Emerald's 80 acres of farm land is not the answer.
3. Review documentation that supports costs provided on Pages 21 and 22 regarding what others have incurred for nitrification and explain why this is not a relevant comparison.
4. Discuss WET test results and fractions potentially assignable to salt and ammonia-nitrogen described on Page 23.
5. Develop effluent limits that Emerald can comply reliably given historical effluent data to address suggested limits on Page 25.

¹ RECOMMENDATION of the ILLINOIS ENVIRONMENTAL PROTECTION AGENCY to deny petitioner's request for an adjusted standard, July 19, 2019.



6. Explain why monitoring ammonia-nitrogen at designated locations will not lead to reduction in effluent ammonia-nitrogen (NH₃-N) loading. Explain that most of the plant's effluent NH₃-N is formed during treatment. TKN is a better indicator. High effluent NH₃-N is due to the absence of nitrification caused by presence of MBT.
7. Update concept design and costs estimates for the top five lowest cost alternatives previously presented based on new design waste load and newer cost estimates. In particular, address tertiary nitrification as mentioned on Page 26, 3c.
8. Again, explain why Page 26, 3a and Page 27, 3f are not key elements. Discharge of NH₃-N is not the critical element.
9. Explain why land application is not a reasonable alternative to address Page 27, 3g.
10. Explain why adding additional biotreaters online will not reduce effluent NH₃-N.
11. Discuss the likely applicability of using an AlgaeWheel to reduce effluent NH₃-N.

A summary of bullets 1-6 and 8-11 will be submitted as a draft report in a white paper report format. A final report will be issued after review by Emerald.

Task 2: Updated Treatment Alternatives Evaluation

Treatment alternatives have been revised and resubmitted by BC since 2011. Treatments previously considered were alkaline air stripping of PC tank contents, alkaline air stripping of PVC tank contents, alkaline air stripping of secondary clarifier effluent, struvite precipitation from combined influent, breakpoint chlorination of secondary clarifier effluent, ion exchange treatment of final effluent, and ozonation of final effluent. A letter report provided to Emerald in 2012 presented a summary of this evaluation. The report provided capital costs along with operation and maintenance (O&M) costs and block flow diagrams (BFDs) associated with these alternatives.

In addition to the 2012 evaluation, BC performed testing in 2016 to understand if nitrification is possible by either activated carbon treated of polymer chemicals (PC) wastewater or if river water dilution of the primary clarifier effluent would allow for nitrification in the downstream treatment plant. Two (2) cost estimates were put together for these alternatives with BFDs. The design basis for this study was based on results from samples to BC by Emerald.

The design basis used in the 2012 evaluation consisted of influent flow, effluent flow, sCOD, BOD, TKN, influent NH₃-N, and effluent NH₃-N. Data from 2002 and 2011 were provided by Emerald and used by BC for that evaluation. The design basis for the 2016 study was based on results from samples sent to BC by Emerald and flows provided to BC by Emerald. BC will develop a new basis of design based on up-to-date waste stream characterization data provided by Emerald.

BC will update the treatment alternatives evaluation that will involve revisiting the top five lowest cost alternatives previously presented (number 7). New alternatives will not be evaluated. The alternatives evaluation will consist of updating capital costs, updating O&M costs, and updating BFDs.

The updated cost estimates will be considered conceptual level Class 5 capital cost estimates. This analysis will be considered an Association for the Advancement of Cost Engineering (AACE) Class 5 estimate. Class 5 estimates are generally prepared based on very limited information, and subsequently have wide accuracy ranges. As such, some companies and organizations have elected to determine that due to the inherent inaccuracies, such estimates cannot be classified in a conventional and systematic manner. Class 5 estimates, due to the requirements of end use, may be prepared within

a very limited amount of time and with little effort expended—sometimes requiring less than an hour to prepare. Often, little more than proposed plant type, location, and capacity are known at the time of estimate preparation. These are typically prepared at 0% to 2% of full project definition.

Typical accuracy ranges for Class 5 estimates are -20% to -50% on the low side, and +30% to +100% on the high side, depending on the technological complexity of the project, appropriate reference information and other risks (after inclusion of an appropriate contingency determination). Ranges could exceed those shown if there are unusual risks.

One draft report will be submitted to address bullet 7 only. The draft report will be submitted as a technical memorandum (TM) and contain the summarized updated basis of design used for the evaluation, capital costs, O&M Costs, and BFDs.

A two (2)-hour report review call has been planned to discuss the draft reports (for Task 1 and Task 2). Final reports will be issued following review of report by Emerald and review call.

Task 3: Deposition and Hearing

As part of this scope of work, Mr. Houston Flippin will attend the deposition currently scheduled for October 2019 and will also attend the hearing in Marshall county currently scheduled for November 2019.

Deliverables

The anticipated deliverables for this scope of work include:

- Report going over on topics 1 - 6 and 8 - 11 described in Task 1. The report will be issued in a white paper report format.
- Report going over topic 7 described in Task 1. This report will be issued as a technical memorandum (TM).
- Five (5) Class 5 capital and operating cost estimates for top five lowest cost alternatives.
- One (1) new block flow diagram to illustrate spray irrigation system.
- Five (5) block flow diagrams will be updated for top five lowest cost alternatives.

Assumptions

BC's scope of work and proposal fee is based on the following assumptions. Any changes to these parameters may have cost and/or schedule implications:

- A report (Report 1) going over topics 1 - 6 and 8 - 11 as described under Task 1.
- A separate TM (Report 2) will be put together addressing Topic 7.
- BC deliverables will consist of one draft and one final white paper report, a separate draft TM, and a final TM. These will be submitted to Emerald electronically.
- Comments on the initial draft reports will be provided within one week of receiving the draft reports. Comments will be addressed by BC the following week and after the review call has taken place. Once comments have been addressed, final reports will be submitted.
- No site visits have been assumed for this scope of work. Visits performed will only be associated with the deposition and hearing.

- No engineering support beyond conceptual design, cost estimating, attendance of deposition, and attendance of hearing are included in this scope.
- A single two (2) hour call has been assumed. This call has been budgeted for up to three (3) BC employees.
- A total of seven (7) days have been budgeted for Mr. Flippin to attend the deposition and hearing in Marshall County.
- Deposition and hearing will only be attended by Mr. Flippin. No other BC staff will attend. Three (3) days have been budgeted for Mr. Flippin to attend the disposition and four (4) days have been budgeted for Mr. Flippin to attend the hearing in Marshall County currently anticipated to occur in the second or third week of November.
- No additional laboratory testing has been assumed for this scope of work.

Proposed Schedule

A summary of the proposed schedule is presented below:

- Receive authorization to proceed by August 21st.
- Submit draft outline of reports by August 23rd.
- Submit draft reports by September 13th.
- Receive comments back on by September 20th.
- Final reports to be submitted by September 27th.
- Attend deposition in October.
- Attend hearing in Marshall County during the second or third week of November.

Project Fee

BC proposes to conduct this scope of work for \$72,900 and will be invoiced on a time and materials cost basis according to the terms included as Attachment A and the labor rate table included as Attachment B.

This fee will not be exceeded without a written change in scope of services and prior authorization by Emerald. This proposal can be accepted by signing the next page and returning a copy of the signed letter to us.

This letter proposal provides the terms, conditions, and obligations that shall control all work. Inconsistent printed terms, if any, contained on Emerald's authorization or reverse sides of an accepted purchase order shall not apply to services provided under this letter proposal, unless expressly agreed by the parties in writing. In the event work is authorized prior to the issuance of a purchase order, any services performed by BC will be presumed to have been completed under the terms of this letter proposal.

Mr. Galen Hathcock
Emerald Performance Materials, LLC
August 19, 2019
Page 5

We appreciate this opportunity to be of service to Emerald. Please call Houston Flippin at 615.250.1220 if you have any questions or need additional information.

Very truly yours,

Brown and Caldwell

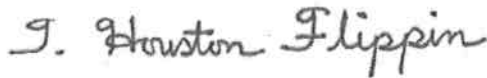

T. Houston Flippin, P.E., BCEE
Industrial Wastewater Process Leader

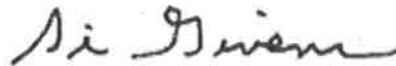

Si Givens
Vice President

THF:na

cc: Charlie Gregory, Brown and Caldwell

Attachments (2):

1. Attachment A: Terms and Conditions
2. Attachment B: Rate Schedule

Limitations:

The information contained in this proposal is proprietary and contains confidential information that is of significant economic value to Brown and Caldwell. It is intended to be used only for evaluation of our qualifications to provide services. It should not be duplicated, used, or disclosed, in whole or in part, for any purpose other than to evaluate this proposal. Further, Client is cautioned that electronic files may be compromised by media degradation, file corruption, incompatibilities, operator inexperience, and file modification. We cannot be responsible for any alteration of these files, or for any use not contemplated by this proposal.

The undersigned agrees to the Terms and Conditions of this Letter Agreement attached hereto.

Emerald Performance Materials, LLC

Signature _____

Printed Name _____

Title _____

Date _____

Attachment A: Terms and Conditions

Brown and Caldwell/Client Standard Terms and Conditions

I. Scope

Brown and Caldwell (BC) agrees to perform the services described in the scope of work attached hereto which incorporates these terms and conditions. Unless modified in writing by the parties hereto, the duties of BC shall not be construed to exceed those services specifically set forth in the proposal. These terms and conditions and the proposal, when executed by Client, shall constitute a binding agreement on both parties (hereinafter the "Agreement").

II. Compensation

Client agrees to pay for the services in Article I in accordance with the compensation provisions in the proposal. Payment to BC will be made within 30 days after the date of billing. Interest on the unpaid balance will accrue beginning on the 31st day at the maximum interest rate permitted by law.

Time-related charges will be made in accordance with the billing rate referenced in the proposal or Agreement. Direct expenses and Subcontractor services shall be billed in accordance with the proposal or compensation exhibit attached to this Agreement. Otherwise, BC's standard billing rates shall apply. In the event any uncontested portions of any invoice are not paid within 30 days of the date of Consultant's invoice, Consultant shall have the right to suspend work per Article XIV, Suspension of Work.

III. Responsibility

Standard of Care. BC is employed to render a professional service only, and any payments made by Client are compensation solely for such services rendered and recommendations made in carrying out the Work. BC shall perform the services in accordance with generally accepted engineering practices and standards in effect when the services are rendered. BC does not expressly or impliedly warrant or guarantee its services.

In performing construction management services, BC shall act as agent of Client. BC's review or supervision of work prepared or performed by other individuals or firms employed by Client shall not relieve those individuals or firms of complete responsibility for the adequacy of their work.

The presence of BC's personnel at a construction site, whether as on-site representative, resident engineer or construction manager, shall be for the sole purpose of determining that the work is generally proceeding in conformance with the intent of the project specifications and contract documents and does not constitute any form of guarantee or assurance with respect to contractor's performance. BC shall have no responsibility for the contractor's means, methods, techniques, sequences, for safety precautions and programs incident to the contractor's work, or for any failure of contractor to comply with laws and regulations applicable to performing its work.

Reliance upon information provided by others. If BC's performance of services hereunder requires BC to rely on information provided by other parties (excepting BC's subcontractors), BC shall not independently verify the validity,

completeness or accuracy of such information unless otherwise expressly engaged to do so in writing by Client.

IV. Indemnification

BC agrees to indemnify and hold Client harmless from and against any liability to the extent arising out of the negligent acts, errors or omissions of BC, its agents, employees, or representatives, in the performance of duties under the Agreement. Regardless of any other term of this Agreement, in no event shall BC be responsible or liable to Client for any incidental, consequential, or other indirect damages.

V. Insurance

BC shall maintain during the life of the Agreement the following minimum insurance:

1. Commercial general liability insurance, including personal injury liability, blanket contractual liability and broad form property damage liability. The combined single limit for bodily injury and property damage shall be not less than \$1,000,000.
2. Automobile bodily injury and property damage liability insurance covering owned, non-owned, rented, and hired cars. The combined single limit for bodily injury and property damage shall be not less than \$1,000,000.
3. Statutory worker's compensation and employers' liability insurance as required by state law.
4. Professional liability insurance with limits of not less than \$1,000,000.

Client shall be named as additional insured on policies 1 and 2 above. Upon request, a certificate of insurance will be provided to Client with a 30-day written notice in the event the above policies are cancelled.

VI. Subcontracts

BC shall be entitled, to the extent determined to be appropriate by BC, to subcontract any portion of the Work to be performed under this Agreement.

VII. Assignment

If the authorized scope of work includes construction activities or the oversight of construction, BC may, at its discretion and upon notice to Client, assign all of its contractual rights and obligations with respect to such activities or services to Brown and Caldwell Constructors, its wholly owned affiliate.

If the authorized scope of work requires professional services to be performed in a jurisdiction in which BC renders professional services solely through a locally registered engineering affiliate for purposes of compliance with professional licensing requirements in that jurisdiction, BC may, in its discretion, upon notice to Client, assign its contractual rights and obligations with respect to such services to such locally registered engineering affiliate.

VIII. Integration

These terms and conditions and the proposal to which they are attached represent the entire understanding of Client and BC as to those matters contained herein. No prior oral or written

Brown and Caldwell/Client

Standard Terms and Conditions (continued)

understanding shall be of any force or effect with respect to those matters covered herein. The Agreement may not be modified or altered except in writing signed by both parties, provided further that any terms and conditions in any client authorization or purchase order issued in connection or under the Agreement which are inconsistent with the Agreement are hereby superseded and shall be of no force and effect.

IX. Choice of Law/Jurisdiction

This Agreement shall be administered and interpreted under the laws of the state in which the BC office responsible for the project is located. Jurisdiction of litigation arising from the Agreement shall be in that state.

X. Severability

If any part of the Agreement is found unenforceable under applicable laws, such part shall be inoperative, null and void insofar as it is in conflict with said laws, but the remainder of the Agreement shall be in full force and effect.

XI. Force Majeure

BC shall not be responsible for delays in performing the scope of services that may result from causes beyond the reasonable control or contemplation of BC. BC will take reasonable steps to mitigate the impact of any force majeure.

XII. No Benefit for Third Parties

The services to be performed by BC hereunder are intended solely for the benefit of Client, and no right nor benefit is conferred on, nor any contractual relationship intended or established with any person or entity not a party to this Agreement. No such person or entity shall be entitled to rely on BC's performance of its services hereunder.

XIII. Work Product

BC and Client recognize that BC's work product submitted in performance of this Agreement is intended only for the Client's benefit and use. Change, alteration, or reuse on another project by Client shall be at Client's sole risk, and Client shall hold harmless and indemnify BC against all losses, damages, costs and expense, including attorneys' fees, arising out of or related to any such unauthorized change, alteration or reuse.

XIV. Suspension Of Work

Work under this Agreement may be suspended as follows:

1. **By Client.** By written notice to BC, Client may suspend all or a portion of the Work under this Agreement if unforeseen circumstances beyond Client's control make normal progress of the Work impracticable. BC shall be compensated for its reasonable expenses resulting from such suspension including mobilization and de-mobilization. If suspension is greater than 30 days, then BC shall have the right to terminate this Agreement in accordance with Article XV, Termination of Work.
2. **By BC.** By written notice to Client, BC may suspend the Work if BC reasonably determines that working conditions at the Site (outside BC's control) are unsafe, or in violation of applicable laws, or in the event Client has not made timely

payment in accordance with Article II, Compensation, or for other circumstances not caused by BC that are interfering with the normal progress of the Work. BC's suspension of Work hereunder shall be without prejudice to any other remedy of BC at law or equity.

XV. Termination of Work

This Agreement may be terminated as follows:

1. **By Client** (a) for its convenience on 30 days' notice to BC, or (b) for cause, if BC materially breaches this Agreement through no fault of Client and BC neither cures such material breach nor makes reasonable progress toward cure within 15 days after Client has given written notice of the alleged breach to BC.
2. **By BC** (a) for cause, if Client materially breaches this Agreement through no fault of BC and Client neither cures such material breach nor makes reasonable progress toward cure within 15 days after BC has given written notice of the alleged breach to Client, or (b) upon five days' notice if Work under this Agreement has been suspended by either Client or BC in the aggregate for more than 30 days.
3. **Payment upon Termination.** In the event of termination, BC shall perform such additional work as is reasonably necessary for the orderly closing of the Work. BC shall be compensated for all work performed prior to the effective date of termination, plus work required for the orderly closing of the Work. Except for termination of BC by Client for cause, BC shall also receive a termination fee equal to 15 percent of the total compensation yet to be earned under existing authorizations at the time of termination.

XVI. Notices

All notices required under this Agreement shall be by personal delivery, facsimile or mail to the BC Project Manager and to the person signing the proposal on behalf of the Client, and shall be effective upon delivery to the addressed stated in the proposal.

Attachment B: Rate Schedule

Brown and Caldwell Schedule of Hourly Billing Rates

Level	Engineering	Technical/Scientific	Administrative	Hourly Rate
A			Office/Support Services I Word Processor I	\$57
B	Drafter Trainee	Field Service Technician I	Office/Support Services II Word Processor II	\$59
C	Assistant Drafter Drafter	Field Service Technician II	Office/Support Services III Accountant I	\$67
D	Engineering Aide Inspection Aide	Field Service Technician III	Word Processor III Office/Support Services IV	\$73
E	Engineer I Senior Drafter Senior Illustrator Inspector I	Geologist/Hydrogeologist I Scientist I Senior Field Service Technician	Accountant II Word Processor IV	\$82
F	Engineer II Inspector II Lead Drafter Lead Illustrator	Geologist/Hydrogeologist II Scientist II	Accountant III Area Business Operations Mgr Technical Writer Word Processing Supervisor	\$104
G	Engineer III Inspector III Senior Designer Supervising Drafter Supervising Illustrator	Geologist/Hydrogeologist III Scientist III	Accountant IV Administrative Manager	\$123
H	Senior Engineer Principal Designer Senior Construction Engineer Senior Engineer	Senior Geologist/Hydrogeologist Senior Scientist	Senior Technical Writer	\$143
I	Principal Engineer Principal Construction Engineer Supervising Designer	Principal Geologist/Hydrogeologist Principal Scientist	Corp. Contract Administrator	\$174
J	Supervising Engineer Supervising Constr. Engineer Supervising Engineer	Supervising Scientist Supervising Geologist/ Hydrogeologist	Assistant Controller	\$202
K	Managing Engineer Chief Engineer	Managing Geologist/Hydrogeologist Managing Scientist	Area Bus Ops Mgr IV	\$237
L	Executive Engineer	Chief Geologist/Hydrogeologist	Corp Marketing Comm. Mgr.	\$260
M	Vice President			\$288
N	Senior Vice President			\$348
O	President/Executive Vice President			\$1
P	Chief Executive Officer			\$1

BC9300

EP002499

220 Athens Way, Suite 500
Nashville, Tennessee 37228

T: 615.255.2288
F: 615.256.8332

August 26, 2019

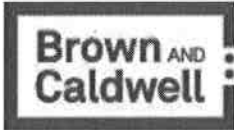

**Letter Proposal
Privileged and Confidential**

Mr. Galen Hathcock
Plant Manager
Emerald Performance Materials, LLC
1150 County Road 1450 North
Henry, Illinois 61537

041514

Subject: Proposal for Assisting in Adjusted Standard Appeal

Dear Mr. Hathcock:

Brown and Caldwell (BC) is pleased to submit this proposal to assist Tom Diamond of ICE MILLER LLP in the defending of the request for an Adjusted Standard for the Emerald Performance Materials, LLC (Emerald) facility in Henry, Illinois.

Scope of Work

This scope of work will consist of addressing specific tasks requested by ICE Miller, updating conceptual cost estimates for the top five lowest cost alternatives previously presented, and attendance by Mr. Houston Flippin to both the deposition and Marshall County hearing.

Task 1: IEPA Recommendations for an Adjusted Standard

As part of this scope of work, BC will address the following specific tasks requested by ICE Miller to address in the Illinois Environmental Protection Agency (IEPA) Recommendations for an Adjusted Standard (Recommendations) are as follows¹:

1. Explain why the cost comparison described on Page 16 is legitimate. IEPA believes these costs do not represent both capital and operating expenses. Explain why present worth costs are a true comparison.
2. Review documentation that supports costs provided on Pages 21 and 22 regarding what others have incurred for nitrification and explain why this is not a relevant comparison.
3. Explain why monitoring ammonia-nitrogen at designated locations will not lead to reduction in effluent ammonia-nitrogen (NH₃-N) loading. Explain that most of the plant's effluent NH₃-N is formed during treatment. Total Kjeldahl Nitrogen (TKN) is a better indicator. High effluent NH₃-N is due to the absence of nitrification caused by presence of Mercaptobenzothiazole (MBT).

¹ RECOMMENDATION of the ILLINOIS ENVIRONMENTAL PROTECTION AGENCY to deny petitioner's request for an adjusted standard, July 19, 2019.



4. Update concept design and costs estimates for the top five lowest cost alternatives previously presented based on new design waste load and newer cost estimates. In particular, address tertiary nitrification as mentioned on Page 26, 3c.
5. Explain why land application is not a reasonable alternative to address Page 27, 3g and Page 18 comments.
6. Explain why adding additional biotreaters online will not reduce effluent $\text{NH}_3\text{-N}$.

A summary of topics 1-3 and 5-6 will be submitted as a draft report in a white paper report format. A final report will be issued after review by Emerald.

Task 2: Updated Treatment Alternatives Evaluation

Treatment alternatives have been revised and resubmitted by BC since 2011. Treatments previously considered were alkaline air stripping of polymer chemicals (PC) tank contents, alkaline air stripping of PVC tank contents, alkaline air stripping of secondary clarifier effluent, struvite precipitation from combined influent, breakpoint chlorination of secondary clarifier effluent, ion exchange treatment of final effluent, and ozonation of final effluent. A letter report provided to Emerald in 2012 presented a summary of this evaluation. The report provided capital costs along with operation and maintenance (O&M) costs and block flow diagrams (BFDs) associated with these alternatives.

In addition to the 2012 evaluation, BC performed testing in 2016 to understand if nitrification is possible by either activated carbon treated of PC wastewater or if river water dilution of the primary clarifier effluent would allow for nitrification in the downstream treatment plant. Two cost estimates were put together for these alternatives with BFDs. The design basis for this study was based on results from samples to BC by Emerald.

The design basis used in the 2012 evaluation consisted of influent flow, effluent flow, sCOD, biochemical oxygen demand (BOD), TKN, influent $\text{NH}_3\text{-N}$, and effluent $\text{NH}_3\text{-N}$. Data from 2002 and 2011 were provided by Emerald and used by BC for that evaluation. The design basis for the 2016 study was based on results from samples sent to BC by Emerald and flows provided to BC by Emerald. BC will develop a new basis of design based on up-to-date waste stream characterization data provided by Emerald.

BC will update the treatment alternatives evaluation that will involve revisiting the top five lowest cost alternatives previously presented (number 7). New alternatives will not be evaluated. The alternatives evaluation will consist of updating capital costs, updating O&M costs, and updating BFDs.

The updated cost estimates will be considered conceptual level Class 5 capital cost estimates. This analysis will be considered an Association for the Advancement of Cost Engineering (AACE) Class 5 estimate. Class 5 estimates are generally prepared based on very limited information, and subsequently have wide accuracy ranges. As such, some companies and organizations have elected to determine that due to the inherent inaccuracies, such estimates cannot be classified in a conventional and systematic manner. Class 5 estimates, due to the requirements of end use, may be prepared within a very limited amount of time and with little effort expended—sometimes requiring less than an hour to prepare. Often, little more than proposed plant type, location, and capacity are known at the time of estimate preparation. These are typically prepared at 0% to 2% of full project definition.

Typical accuracy ranges for Class 5 estimates are -20% to -50% on the low side, and +30% to +100% on the high side, depending on the technological complexity of the project, appropriate reference information and other risks (after inclusion of an appropriate contingency determination). Ranges could exceed those shown if there are unusual risks.

One draft report will be submitted to address topic 4 only. The draft report will be submitted as a technical memorandum (TM) and contain the summarized updated basis of design used for the evaluation, capital costs, O&M Costs, and BFDs.

A two-hour report review call has been planned to discuss the draft reports (for Task 1 and Task 2). Final reports will be issued following review of report by Emerald and review call.

Task 3: Deposition and Hearing

As part of this scope of work, Mr. Houston Flippin will attend the deposition currently scheduled for October 2019 and will also attend the hearing in Marshall county currently scheduled for November 2019.

Deliverables

The anticipated deliverables for this scope of work include:

- Report going over on topics 1-3 and 5-6 described in Task 1. The report will be issued in a white paper report format.
- Report going over topic 4 described in Task 1. This report will be issued as a technical memorandum (TM).
- Five Class 5 capital and operating cost estimates for top five lowest cost alternatives.
- One new block flow diagram to illustrate spray irrigation system.
- Five block flow diagrams will be updated for top five lowest cost alternatives.

Assumptions

BC's scope of work and proposal fee is based on the following assumptions. Any changes to these parameters may have cost and/or schedule implications:

- A report (Report 1) going over topics 1-3 and 5-6 as described under Task 1.
- A separate TM (Report 2) will be put together addressing Topic 4.
- BC deliverables will consist of one draft and one final white paper report, a separate draft TM, and a final TM. These will be submitted to Emerald electronically.
- Comments on the initial draft reports will be provided within one week of receiving the draft reports. Comments will be addressed by BC the following week and after the review call has taken place. Once comments have been addressed, final reports will be submitted.
- No site visits have been assumed for this scope of work. Visits performed will only be associated with the deposition and hearing.
- No engineering support beyond conceptual design, cost estimating, attendance of deposition, and attendance of hearing are included in this scope.
- A single two hour call has been assumed. This call has been budgeted for up to three BC employees.

- A total of seven days have been budgeted for Mr. Flippin to attend the deposition and hearing in Marshall County.
- Deposition and hearing will only be attended by Mr. Flippin. No other BC staff will attend. Three days have been budgeted for Mr. Flippin to attend the disposition and four days have been budgeted for Mr. Flippin to attend the hearing in Marshall County currently anticipated to occur in the second or third week of November.
- No additional laboratory testing has been assumed for this scope of work.

Proposed Schedule

A summary of the proposed schedule is presented below:

- Receive authorization to proceed by August 27st.
- Submit draft outline of reports by August 29rd.
- Submit draft reports by September 20th.
- Receive comments back on by September 25th.
- Final reports to be submitted by September 30th.
- Attend deposition in October.
- Attend hearing in Marshall County during the second or third week of November.

Project Fee

BC proposes to conduct this scope of work for **\$63,700 inclusive of \$18,400 set aside for the deposition and hearing**. This fee will be invoiced on a time and materials cost basis according to the terms included as Attachment A and the labor rate table included as Attachment B.

This fee will not be exceeded without a written change in scope of services and prior authorization by Emerald. This proposal can be accepted by signing the next page and returning a copy of the signed letter to us.

This letter proposal provides the terms, conditions, and obligations that shall control all work. Inconsistent printed terms, if any, contained on Emerald's authorization or reverse sides of an accepted purchase order shall not apply to services provided under this letter proposal, unless expressly agreed by the parties in writing. In the event work is authorized prior to the issuance of a purchase order, any services performed by BC will be presumed to have been completed under the terms of this letter proposal.

Mr. Galen Hathcock
Emerald Performance Materials, LLC
August 26, 2019
Page 5

We appreciate this opportunity to be of service to Emerald. Please call Houston Flippin at 615.250.1220 if you have any questions or need additional information.

Very truly yours,

Brown and Caldwell

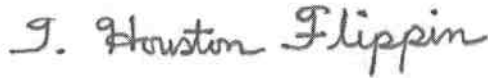

T. Houston Flippin, P.E., BCEE
Industrial Wastewater Process Leader

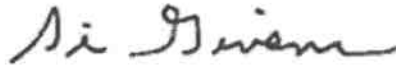

Si Givens
Vice President

THF:na

cc: Charlie Gregory, Brown and Caldwell

Attachments (2):

1. Attachment A: Terms and Conditions
2. Attachment B: Rate Schedule

Limitations:

The information contained in this proposal is proprietary and contains confidential information that is of significant economic value to Brown and Caldwell. It is intended to be used only for evaluation of our qualifications to provide services. It should not be duplicated, used, or disclosed, in whole or in part, for any purpose other than to evaluate this proposal. Further, Client is cautioned that electronic files may be compromised by media degradation, file corruption, incompatibilities, operator inexperience, and file modification. We cannot be responsible for any alteration of these files, or for any use not contemplated by this proposal.

The undersigned agrees to the Terms and Conditions of this Letter Agreement attached hereto.

Emerald Performance Materials, LLC

Signature _____

Printed Name _____

Title _____

Date _____

Attachment A: Terms and Conditions

Brown and Caldwell/Client Standard Terms and Conditions

I. Scope

Brown and Caldwell (BC) agrees to perform the services described in the scope of work attached hereto which incorporates these terms and conditions. Unless modified in writing by the parties hereto, the duties of BC shall not be construed to exceed those services specifically set forth in the proposal. These terms and conditions and the proposal, when executed by Client, shall constitute a binding agreement on both parties (hereinafter the "Agreement").

II. Compensation

Client agrees to pay for the services in Article I in accordance with the compensation provisions in the proposal. Payment to BC will be made within 30 days after the date of billing. Interest on the unpaid balance will accrue beginning on the 31st day at the maximum interest rate permitted by law.

Time-related charges will be made in accordance with the billing rate referenced in the proposal or Agreement. Direct expenses and Subcontractor services shall be billed in accordance with the proposal or compensation exhibit attached to this Agreement. Otherwise, BC's standard billing rates shall apply. In the event any uncontested portions of any invoice are not paid within 30 days of the date of Consultant's invoice, Consultant shall have the right to suspend work per Article XIV, Suspension of Work.

III. Responsibility

Standard of Care. BC is employed to render a professional service only, and any payments made by Client are compensation solely for such services rendered and recommendations made in carrying out the Work. BC shall perform the services in accordance with generally accepted engineering practices and standards in effect when the services are rendered. BC does not expressly or impliedly warrant or guarantee its services.

In performing construction management services, BC shall act as agent of Client. BC's review or supervision of work prepared or performed by other individuals or firms employed by Client shall not relieve those individuals or firms of complete responsibility for the adequacy of their work.

The presence of BC's personnel at a construction site, whether as on-site representative, resident engineer or construction manager, shall be for the sole purpose of determining that the work is generally proceeding in conformance with the intent of the project specifications and contract documents and does not constitute any form of guarantee or assurance with respect to contractor's performance. BC shall have no responsibility for the contractor's means, methods, techniques, sequences, for safety precautions and programs incident to the contractor's work, or for any failure of contractor to comply with laws and regulations applicable to performing its work.

Reliance upon information provided by others. If BC's performance of services hereunder requires BC to rely on information provided by other parties (excepting BC's subcontractors), BC shall not independently verify the validity,

completeness or accuracy of such information unless otherwise expressly engaged to do so in writing by Client.

IV. Indemnification

BC agrees to indemnify and hold Client harmless from and against any liability to the extent arising out of the negligent acts, errors or omissions of BC, its agents, employees, or representatives, in the performance of duties under the Agreement. Regardless of any other term of this Agreement, in no event shall BC be responsible or liable to Client for any incidental, consequential, or other indirect damages.

V. Insurance

BC shall maintain during the life of the Agreement the following minimum insurance:

1. Commercial general liability insurance, including personal injury liability, blanket contractual liability and broad form property damage liability. The combined single limit for bodily injury and property damage shall be not less than \$1,000,000.
2. Automobile bodily injury and property damage liability insurance covering owned, non-owned, rented, and hired cars. The combined single limit for bodily injury and property damage shall be not less than \$1,000,000.
3. Statutory worker's compensation and employers' liability insurance as required by state law.
4. Professional liability insurance with limits of not less than \$1,000,000.

Client shall be named as additional insured on policies 1 and 2 above. Upon request, a certificate of insurance will be provided to Client with a 30-day written notice in the event the above policies are cancelled.

VI. Subcontracts

BC shall be entitled, to the extent determined to be appropriate by BC, to subcontract any portion of the Work to be performed under this Agreement.

VII. Assignment

If the authorized scope of work includes construction activities or the oversight of construction, BC may, at its discretion and upon notice to Client, assign all of its contractual rights and obligations with respect to such activities or services to Brown and Caldwell Constructors, its wholly owned affiliate.

If the authorized scope of work requires professional services to be performed in a jurisdiction in which BC renders professional services solely through a locally registered engineering affiliate for purposes of compliance with professional licensing requirements in that jurisdiction, BC may, in its discretion, upon notice to Client, assign its contractual rights and obligations with respect to such services to such locally registered engineering affiliate.

VIII. Integration

These terms and conditions and the proposal to which they are attached represent the entire understanding of Client and BC as to those matters contained herein. No prior oral or written

Brown and Caldwell/Client Standard Terms and Conditions (continued)

understanding shall be of any force or effect with respect to those matters covered herein. The Agreement may not be modified or altered except in writing signed by both parties, provided further that any terms and conditions in any client authorization or purchase order issued in connection or under the Agreement which are inconsistent with the Agreement are hereby superseded and shall be of no force and effect.

IX. Choice of Law/Jurisdiction

This Agreement shall be administered and interpreted under the laws of the state in which the BC office responsible for the project is located. Jurisdiction of litigation arising from the Agreement shall be in that state.

X. Severability

If any part of the Agreement is found unenforceable under applicable laws, such part shall be inoperative, null and void insofar as it is in conflict with said laws, but the remainder of the Agreement shall be in full force and effect.

XI. Force Majeure

BC shall not be responsible for delays in performing the scope of services that may result from causes beyond the reasonable control or contemplation of BC. BC will take reasonable steps to mitigate the impact of any force majeure.

XII. No Benefit for Third Parties

The services to be performed by BC hereunder are intended solely for the benefit of Client, and no right nor benefit is conferred on, nor any contractual relationship intended or established with any person or entity not a party to this Agreement. No such person or entity shall be entitled to rely on BC's performance of its services hereunder.

XIII. Work Product

BC and Client recognize that BC's work product submitted in performance of this Agreement is intended only for the Client's benefit and use. Change, alteration, or reuse on another project by Client shall be at Client's sole risk, and Client shall hold harmless and indemnify BC against all losses, damages, costs and expense, including attorneys' fees, arising out of or related to any such unauthorized change, alteration or reuse.

XIV. Suspension Of Work

Work under this Agreement may be suspended as follows:

1. **By Client.** By written notice to BC, Client may suspend all or a portion of the Work under this Agreement if unforeseen circumstances beyond Client's control make normal progress of the Work impracticable. BC shall be compensated for its reasonable expenses resulting from such suspension including mobilization and de-mobilization. If suspension is greater than 30 days, then BC shall have the right to terminate this Agreement in accordance with Article XV, Termination of Work.
2. **By BC.** By written notice to Client, BC may suspend the Work if BC reasonably determines that working conditions at the Site (outside BC's control) are unsafe, or in violation of applicable laws, or in the event Client has not made timely

payment in accordance with Article II, Compensation, or for other circumstances not caused by BC that are interfering with the normal progress of the Work. BC's suspension of Work hereunder shall be without prejudice to any other remedy of BC at law or equity.

XV. Termination of Work

This Agreement may be terminated as follows:

1. **By Client** (a) for its convenience on 30 days' notice to BC, or (b) for cause, if BC materially breaches this Agreement through no fault of Client and BC neither cures such material breach nor makes reasonable progress toward cure within 15 days after Client has given written notice of the alleged breach to BC.
2. **By BC** (a) for cause, if Client materially breaches this Agreement through no fault of BC and Client neither cures such material breach nor makes reasonable progress toward cure within 15 days after BC has given written notice of the alleged breach to Client, or (b) upon five days' notice if Work under this Agreement has been suspended by either Client or BC in the aggregate for more than 30 days.
3. **Payment upon Termination.** In the event of termination, BC shall perform such additional work as is reasonably necessary for the orderly closing of the Work. BC shall be compensated for all work performed prior to the effective date of termination, plus work required for the orderly closing of the Work. Except for termination of BC by Client for cause, BC shall also receive a termination fee equal to 15 percent of the total compensation yet to be earned under existing authorizations at the time of termination.

XVI. Notices

All notices required under this Agreement shall be by personal delivery, facsimile or mail to the BC Project Manager and to the person signing the proposal on behalf of the Client, and shall be effective upon delivery to the addressed stated in the proposal.

Attachment B: Rate Schedule

Brown and Caldwell Schedule of Hourly Billing Rates

Level	Engineering	Technical/Scientific	Administrative	Hourly Rate
A			Office/Support Services I Word Processor I	\$57
B	Drafter Trainee	Field Service Technician I	Office/Support Services II Word Processor II	\$59
C	Assistant Drafter	Field Service Technician II	Office/Support Services III Accountant I	\$67
D	Drafter Engineering Aide Inspection Aide	Field Service Technician III	Word Processor III Office/Support Services IV	\$73
E	Engineer I Senior Drafter Senior Illustrator Inspector I	Geologist/Hydrogeologist I Scientist I Senior Field Service Technician	Accountant II Word Processor IV	\$82
F	Engineer II Inspector II Lead Drafter Lead Illustrator	Geologist/Hydrogeologist II Scientist II	Accountant III Area Business Operations Mgr Technical Writer Word Processing Supervisor	\$104
G	Engineer III Inspector III Senior Designer Supervising Drafter Supervising Illustrator	Geologist/Hydrogeologist III Scientist III	Accountant IV Administrative Manager	\$123
H	Senior Engineer Principal Designer Senior Construction Engineer Senior Engineer	Senior Geologist/Hydrogeologist Senior Scientist	Senior Technical Writer	\$143
I	Principal Engineer Principal Construction Engineer Supervising Designer	Principal Geologist/Hydrogeologist Principal Scientist	Corp.Contract Administrator	\$174
J	Supervising Engineer Supervising Constr. Engineer Supervising Engineer	Supervising Scientist Supervising Geologist/ Hydrogeologist	Assistant Controller	\$202
K	Managing Engineer	Managing Geologist/Hydrogeologist Managing Scientist	Area Bus Ops Mgr IV	\$237
L	Chief Engineer Executive Engineer	Chief Scientist Chief Geologist/Hydrogeologist	Corp Marketing Comm. Mgr.	\$260
M	Vice President			\$288
N	Senior Vice President			\$348
O	President/Executive Vice President			\$1
P	Chief Executive Officer			\$1

BC9300

EP002481